

Safety Laser Scanner

UAM-05LP

User's Manual



Table of contents

1. Introduction	6
1.1 About this manual	6
1.2 Applicable products.....	6
1.3 Abbreviations	6
1.4 Special markings and symbols	6
1.5 Applicable directives and standards	7
1.6 Registered trademarks.....	7
2. Safety precautions	8
2.1 General precautions	8
2.2 Operating environment.....	9
2.3 Installation of UAM.....	9
2.4 Wiring.....	9
2.5 Configuration.....	10
2.6 Inspection and maintenance	10
3. Product overview	12
3.1 Features of UAM-05LP.....	12
3.1.1 UAM version and function compatibility	13
3.2 Components of UAM-05LP	14
3.3 Operation principle	16
3.4 Scanning area.....	17
3.4.1 Protection zone.....	17
3.4.2 Warning zone	19
3.5 Area switching.....	20
3.6 Incremental encoder.....	24
3.6.1 Pulse per cm travel generated by incremental encoders	25
3.6.2 Recommend incremental encoder specification	26
3.6.3 Tolerances allowed for encoder	26
3.6.4 Area switching by encoder input	27
3.7 OSSD	28
3.7.1 Self-diagnostic function of OSSD	29
3.7.2 Lockout state.....	29
3.7.3 Interlock function	30
3.8 External device monitoring (EDM) function	32
3.9 Muting function	33
3.9.1 Muting start condition.....	33
3.9.2 Muting stop condition	34
3.9.3 Muting override function.....	35
3.10 Reference monitoring function.....	36



3.10.1 Area protection.....	36
3.10.2 Access protection.....	37
3.11 Area sequence function.....	39
3.12 Response time	39
3.13 Other outputs.....	40
3.13.1 Warning output 1 (WARNING 1)	41
3.13.2 Warning output 2 (WARNING 2)	41
3.13.3 Muting output 1 (MUT_OUT 1).....	41
3.13.4 Muting output 2 (MUT_OUT 2).....	41
3.13.5 Reset Request 1 (RES _ REQ1)	41
3.13.6 Reset Request 2 (RES _ REQ2)	41
3.13.7 Auxiliary Output 1 (AUX_OUT1).....	41
3.13.8 Auxiliary Output 2 (AUX_OUT2).....	41
3.14 Information indicator.....	41
3.14.1 LED.....	43
3.14.2 7-Segment display	43
3.15 Ethernet communication	44
3.15.1 Ethernet Setting	44
3.16 Function to configure UAM by SD card.....	45
3.17 Master-Slave Function	45
3.18 Laser Off Mode.....	47
3.19 Scan Skip Function.....	47
3.20 Optical Window Contamination Warning Function	49
3.21 Auxiliary Output Function	49
4. Application examples of UAM.....	51
4.1 Access protection (Horizontal application Stationary Protection zone 1)	51
4.2 Access protection (Stationary Horizontal application with Dual Protection zone)	53
4.3 Access protection (Vertical application- whole body detection)	54
4.4 Access protection (Vertical application Stationary)	56
4.5 Area protection (Horizontal application Mobile) Fixed area.....	58
4.6 Area protection (Mobile, Horizontal, Single Protection, Variable Area)	61
4.7 Area protection (Mobile, Horizontal, Single Protection, Encoder Input).....	62
4.8 Area protection (Mobile, Horizontal, 2 Units Interconnected, Variable	62
4.9 Area protection (Mobile, Horizontal, 4 Units Interconnected, Variable Area)	63
4.10 Area protection (Mobile, Horizontal, Autonomous Navigation)	64
4.11 Default Values	64
5. Installation	66
5.1 Light interference	66



5.2 Mutual interference.....	67
5.3 High reflective background	69
5.4 Limited detection capability zone	70
6. Wiring.....	71
6.1 Precautions.....	71
6.2 Power supply.....	71
6.3 Wire color and function	71
6.4 Wiring example.....	73
6.5 Input/ Output circuit.....	78
6.5.1 OSSD/ Warning Output circuit	78
6.5.2 Other output circuits	78
6.5.3 Input circuit	79
7. Function configuration of UAM.....	80
7.1 About UAM Project Designer application.....	80
7.2 System requirements.....	80
7.3 Installatiion of UAM Project Designer	81
7.3.1 Uninstallation UAM Project Designer	81
7.4 Device driver installation	82
7.4.1 Installing the driver in Windows 8	82
7.4.2 Installing the driver in Windows 7	84
7.4.3 Installing the driver in Windows XP.....	89
7.4.4 Installing the driver in Windows 10	89
7.5 Starting the UAM Project Designer.....	90
7.5.1 Startup Main window.....	90
7.5.2 Create new configuration.....	91
7.5.3 Open configuration file or measurement data file	92
7.5.4 Connect to UAM	92
7.6 Components of UAM Project Designer	94
7.7 Menu bar	95
7.7.1 File.....	95
7.7.2 Edit.....	95
7.7.3 Mode	96
7.7.4 Connection.....	96
7.7.5 Option	97
7.7.6 Language	97
7.7.7 Help.....	98
7.8 Tool bar.....	99
7.9 Subpanel.....	100
7.9.1 Configuration tab	100



7.9.2 Monitor tab	111
7.9.3 Report tab.....	112
7.10 Status bar	115
7.11 Connecting UAM with PC	115
7.12 Password	116
7.12.1 Changing the password	116
7.12.2 Reclaim the forgotten password	117
7.13 Configuration mode	117
7.14 Function configuration.....	118
7.15 Area configuration.....	119
7.15.1 Area configuration by drawing tools.....	120
7.15.2 Area configuration by teaching function	122
7.15.3 Muting configuration	124
7.15.4 Reference region configuration	125
7.16 Transmit configurations to UAM.....	126
7.17 Save project file	127
7.18 Read configuration from UAM	129
7.19 Open project file	129
7.20 Recording the UAM data.....	130
7.21 Replay the log data.....	132
7.22 Save settings to SD card.....	133
7.23 UAM configuration through SD card.....	135
8. Inspection and maintenance	135
8.1 Pre-operation inspection	135
8.2 Operation inspection	137
8.3 Daily inspection	138
8.4 Periodical inspection	139
8.5 Cleaning the optical window	141
8.6 Replacing the optical window.....	141
8.6.1 Method of replacing the optical window.....	141
8.6.2 Adjustment of the optical window.....	143
9. Troubleshooting	145
10. Specification	150
10.1 UAM-05LP	150
11. Package contents.....	153
12. Options	154
12.1 Base mounting bracket (Model: UAM-BK03)	154
12.2 Rear mounting bracket (Model: UAM-BK04).....	154



12.3 USB cable (Model: UAM-MUSB)	154
12.4 Ethernet cable (Model: UAM-ENET)	154
12.5 Configuration CD (Model: UAM-CD03).....	154
12.6 Optical window for replacement (Model: UAM-W002)	155
12.7 Cover Bracket (Type: UAM-BK05)	155
12.8 Connector Cable (UAM-05LP-T301C Only)	155
13. External dimension.....	156
13.1 UAM-05LP	156
13.2 Base mounting bracket	157
13.3 Rear mounting bracket	158
13.4 Cover Protection Bracket	159
14. EC Declaration of conformity	160
15. Revision history	162
16. Representative contacts.....	163



1. Introduction

This user's manual is designed with the purpose of providing guidelines and instructions for the machine user or system designer while operating, installing, wiring and servicing the UAM-05LP.

1.1 About this manual

UAM's features, installation and handling method are described in this document.

- Read this document carefully before installation, wiring, operation, inspection and maintenance.
- User should have a copy of this document at an easy-to-access place for quick reference.
- Information provided in this document is subject to change without prior notice. For the latest information visit the company's website <http://www.hokuyo-aut.jp>
- Actual product may differ from the illustrations and figures in this document as they are used for explanatory purpose only.

1.2 Applicable products

This document is for the following sensor model.

- UAM-05LP-T301
- UAM-05LP-T301C

1.3 Abbreviations

The list below shows abbreviations used in this document.

Table 1-1 Abbreviations



Abbreviation	Meaning
AGV	Automated guided vehicle
AOPDDR	Active optoelectronic protective device responsive to diffuse reflection
AWG	American wire gage
EDM	External device monitoring
EMC	Electromagnetic compatibility
MSCE	Machine secondary control element
OSSD	Output signal switching device
SELV	Safety extra low voltage

1.4 Special markings and symbols

Markings and symbols are used in this document to alert the user about safety-related issues. Follow the instructions of these special markings and symbols to ensure safety during the operation.



Table 1-2 Special markings and symbols

Mark	Meaning
 Danger	Procedures that could lead to dangerous situation, critical injury or death if not carried out properly
 Caution	Procedures that could lead to dangerous situation, serious injury or physical damage if not carried out properly
Note	Points that should be considered for the proper operation

1.5 Applicable directives and standards

UAM is certified by TUV SUD Product Service GmbH and UL/c-UL, FDA (CDRH) as a safety sensor defined in EU Machine Directive (2006/42/EC).

Table 1-3 Applicable directives and standards

Certified authority	Directives/Standard	Details	
TUV SUD	EU directives	Machinery Directive: Directive 2006/42/EC	
		EMC Directive: Directive 2014/30/EU	
	EN standards IEC standards ISO standards	IEC61496-1:2012 EN 61496-1:2013	Type 3
		IEC 61496-3:2008	Type 3
		IEC 61508 Part1-7:2010	SIL2
		EN 62061:2005/A2: :2015	SIL2
		EN ISO13849-1:2015	Category 3, PLd
IEC60825-1:2014	Safety of laser products Class 1		
UL/c-UL	UL standards IEC standards ISO standards CSA standards	UL 508:2010	
		ANSI/UL 1998:2013	
		IEC 61496-1:2012	Type 3
		IEC 61496-3:2008	Type 3
		IEC 61508 Part1-7:2010	SIL2
		ISO13849-1:2006	Category 3, PLd
FDA (CDRH)		21 CFR Part 1040.10 and 1040.11	Safety of laser products Class 1

1.6 Registered trademarks

- Microsoft[®], Windows[®] are the registered trademarks of Microsoft Corporation USA.
- Pentium[®] is the registered trademark of Intel Corporation.
- Other products mentioned in the document are trademarks or registered trademarks of the respective companies.



2. Safety precautions



Caution

- Read the following guidelines for correct use of the UAM. Proper handling and usage will ensure the UAM to operate accordingly.

2.1 General precautions

- UAM is designed to protect human beings or systems by monitoring the hazardous area. It is not designed for the protection from high speed objects or the electromagnetic radiation.
- Perform pre-operation tests in order to verify the performance of UAM.
- Do not modify or disassemble UAM. Such modifications will affect the detection capability leading to injuries or death.
- Do not modify or disassemble UAM to maintain its housing rating. Such modifications will void the warranty.
- The person-in-charge should be qualified to operate UAM. The person must be trained, on safety requirements with necessary cautions for handling the device.
- The person-in-charge should train the user with correct installation, operation, inspection and maintenance procedures.
- The person-in-charge is responsible to ensure the proper working environment for UAM.
- The person-in-charge is responsible for the compliance with the local safety requirements, standards, rules and regulations, laws of respective nations, states or districts when UAM is used in a safety-related system.
- UAM has been manufactured and shipped under the strict quality control. If you find any defect in the product contact the nearest distributor or sales representative. (📄 Last page)
- Hokuyo cannot be held responsible for the damages or failure due to misuse of the product.
- User should prepare test pieces for detection capability verification. The test piece should emulate the smallest object that is intended to be detected during the operation.
- Maximum level of homogeneous pollution for UAM to operate normally is under 30%. UAM will report error if the pollution exceeds the stated limit. Always keep the optical window in clean condition to avoid the error.
- Before resetting the interlock of UAM, user must ensure the surrounding is safe especially the protected area.
- Apply sufficient measures to ensure safety of the protected area when decommissioning UAM. Protective materials such as guards or light curtain should be used to prevent the passage to the hazardous area.
- UAM including its accessories are subject to change without prior notice for the improvement.
- UAM should be disposed as industrial waste or in accordance with the local disposal directives.



2.2 Operating environment

- Make sure that UAM's operating environment is within the stated specification (temperature, humidity, vibration, ambient light, etc.)
- Do not use or mount UAM near devices that could generate strong electromagnetic waves as it could affect the operation of UAM.
- Do not use or mount UAM in dusty, smoky, or misty environments, or where corrosive substances are present. Operating under such environments may decrease the detection capacity of UAM.
- This product is for indoor use only.

2.3 Installation of UAM

- Install UAM on a firm surface or structure to avoid displacement.
- UAM should be firmly mounted using the screws (recommended torque for screws is 3N.m.). Shock and vibration should not loosen the mounting. Detection may fail if actual protection zone differs from the intended zone due to displacement of UAM.
- Safety distance should be determined before installing UAM. User must verify the function of UAM after installation by placing a test piece at all the positions of protection zone (refer to chapter 4 for the details on the safety distance calculation for various applications).
- When installing the UAM, protective materials such as guards or light curtain should be used to prevent any passage into the hazardous area.
- Reset switch used for interlock, muting and override function should be mounted at a location away from the protection zone.
- Mutual interference can occur when identical UAMs are mounted at the same detection plane. Refer to chapter 5 for countermeasures to avoid mutual interference.
- UAM should be mounted at the location which has sufficient space for maintenance.
- Do not add any protective materials such as, glass and transparent cover, in front of the optical window. This could lead to loss of detection capability of the UAM.
- Minimum detectable width varies with the distance. Refer to chapter 10 for details.

2.4 Wiring

- Switch off all the power supplies during wiring.
- When a converter is used for supplying the power, make sure it fulfills the following requirements.
 - A rated output voltage within the range of DC 24V±10% (SELV circuit, Category II).
 - Reinforced insulation or double insulation for the primary and secondary circuit.
 - Holding time of the output should be above 20ms.
 - The power supply complies with the requirements of electromagnetic compatibility regulations (EMC) of the respective country, state and district.
- All the input/output signal cables should be installed away from machines power lines and high-voltage cables.



-
- Use the OSSD signal of UAM to control safety-related machines or control system. Do not use warning signals to control safety related machine as these are non safety signals.
 - Both the OSSD1 and OSSD2 outputs should be connected to the safety-related machines or control system. If OSSD3 and OSSD4 are used they must be connected in the same manner.
 - Use shield cable for the connection between OSSD signals and safety-related machines or systems. Cable length should not exceed the specification.

2.5 Configuration

- Configuration of safety functions are password protected. Only authorized users with password are allowed to configure UAM.
- UAM does not operate without initial configuration.
- Pre-operation tests should be performed to verify the configurations before operating the UAM.
- Increasing the response time of OSSD will increase the stability of UAM. However, this will reduce the detection capability towards moving objects. User must perform risk assessment before using this function.
- Changes made during the configuration must be recorded and saved. Use the report function in the UAM Project Designer for this purpose. (📖 page 100)

2.6 Inspection and maintenance

- User must perform inspection and maintenance by referring to the checklists provided in this document (📖 Chapter 8, page 123)
 - Pre-operation inspection
 - Operation inspection
 - Daily inspection
 - Periodic inspection

The checklists in this document are provided as basic guidelines while performing the test and maintenance. User must perform additional inspection and maintenance tasks deemed necessary for the respective application.

- Stop the machine and system if faults are detected during these tests.
- Clean the optical window when it gets contaminated. If the optical window is damaged it should be replaced by a new one.



Danger

- For the repair of UAM, contact the nearest distributor or sales representative. User should not repair or disassemble UAM.



Note

- Safety Standard Class 1 Laser of UAM-05LP: It is guaranteed as safety class laser. Additional measures are not necessary to maintain the laser safety.
- Caution - Use of controls or adjustments or performance of procedures other than those specified herein may result in hazardous radiation exposure.



UAM-05LP-T301	S/N: H000000
Code:*****	July, 2015
Supply voltage: 24VDC+20%/-30%	
Rated power (without load): 6W	
Protection range: max. 5m	
Response time (Adj.): min. 60ms	
Min. detectable width: 30mm trough 70mm	
Detection range: 270°	
Enclosure: IP65	
OSSD1/2: max. 500mA, OSSD3/4: max. 250mA	
Temperature: -10°C to 50°C	

Class 1 Laser Product: IEC60825-1 (2007 & 2014)
Complies with 21 CFR Parts 1040.10 and 1040.11 except for deviations pursuant to Laser Notice No.50, dated June 24, 2007.
Safety Category: Type3 (IEC61496-3)

 **FUNCTIONAL SAFETY** AOPDDR 4PY9
 ALSO INVESTIGATED TO IEC 61508-, Parts 1-3, 2nd ED. 2010, UP TO SIL 2
ISO13849-1, 2nd ED. 2006, UP TO PL d, Category 3
See installation manual for safety functions

  **HOKUYO AUTOMATIC CO.,LTD.**
Osaka HU Building, 2-2-5 Tokiwamachi, Chuo-ku,
Osaka 540-0028 Japan

MADE IN JAPAN

Figure 2-1 Example of product labels

3. Product overview

UAM emits pulsed laser beam which is reflected on a rotating mirror within the configured protection zone. When the emitted laser beams are reflected back from an object its distance is measured. This chapter describes the features and properties of UAM.

3.1 Features of UAM-05LP

- Protection range: Maximum 5m (📖 page 136)
- Warning range: Maximum 20m (📖 page 136)
- Detection angle: 270°(📖 page 15)
- Minimum response time of 60ms (Configurable) (📖 page 39)
- 32 set of areas (Configurable) *1 *2(📖 page 20)
- 2 modes of scanning area setting (📖 page 20)
- Dual Protection Mode (Configurable) (📖 page 17)
- Scanning area switch through incremental encoder input (Configurable) (📖 page 24)
- Interlock function (Configurable) (📖 page 30)
- EDM function (Configurable) (📖 page 32)
- Muting /Override function (Configurable) (📖 page 33)
- Reference monitor function (Configurable) (📖 page 36)
- Area sequence function (Configurable) (📖 page 39)
- LED indicator for UAMs status (📖 page 41)
- 7-segment display (📖 page 42)
- Ethernet communication (📖 page 43)
- A maximum of 4 sensors for master/slave operation (📖 page 44)
- Configuration with SD card (📖 page 44)
- Easy configuration with UAM configuration application software installed in PC (📖 page 73)

*1: Depending on the used functions, maximum area varies from 2 to 32 sets of area.

*2: Maximum configurable area in encoder input mode is 128.

3.1.1 UAM version and function compatibility

Table below shows the compatible functions depending on the firmware version of UAM. Device version can be verified using the configuration software “UAM Project Designer”.

Main functions	UAM Version			
	Older than 2.0.0	2.0.0 and above	2.1.1 and above	2.4.0 and above
Scan area switching	✓	✓	✓	✓
Encoder input	✓	✓	✓	✓
Interlock	✓	✓	✓	✓
EDM	✓	✓	✓	✓
Muting	✓	✓	✓	✓
Reference monitoring	✓	✓	✓	✓
Area sequence	✓	✓	✓	✓
Ethernet communication	✓	✓	✓	✓
Setting via SD card	✓	✓	✓	✓
Master-Slave mode	✓	✓	✓	✓
7-segment LED upside down display		✓	✓	✓
Laser off mode		✓	✓	✓
Scan skip mode		✓	✓	✓
Contamination warning			✓	✓
Auxiliary output				✓



3.2 Components of UAM-05LP

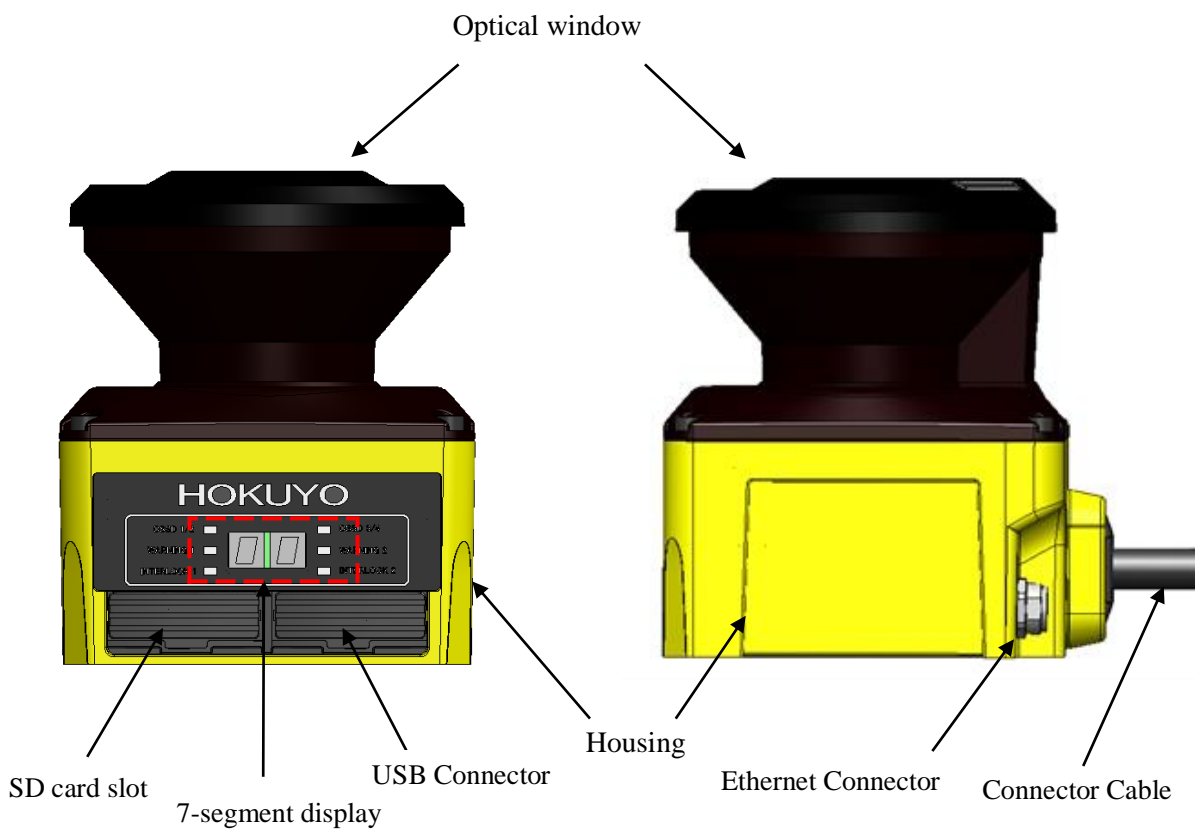

Figure 3-1 UAM-05LP components

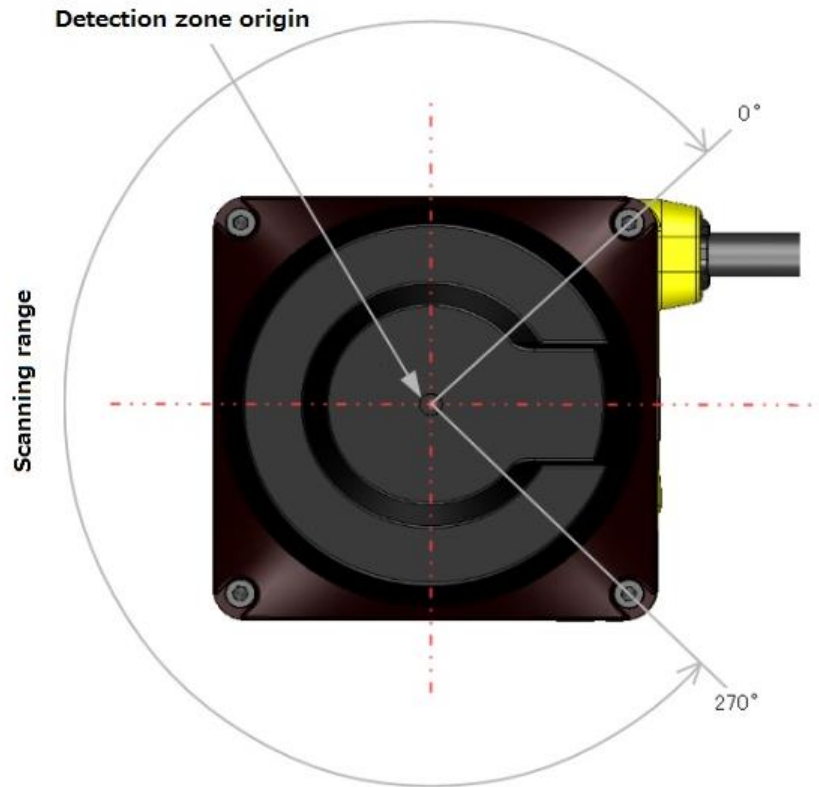

Figure 3-2 Scanning range and detection zone origin (Top view)

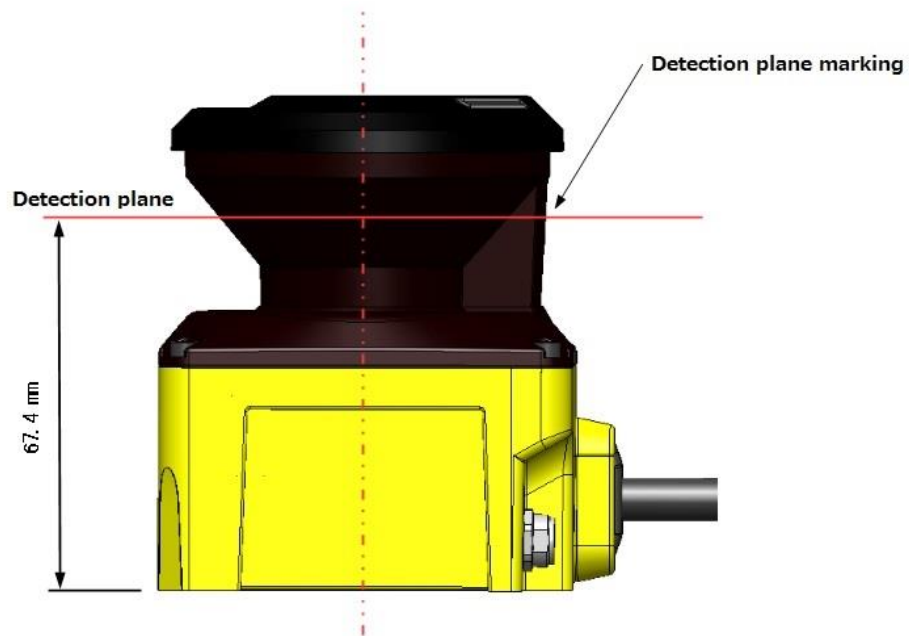

Figure 3-3 Detection plane of UAM-05LP (Side view)

3.3 Operation principle

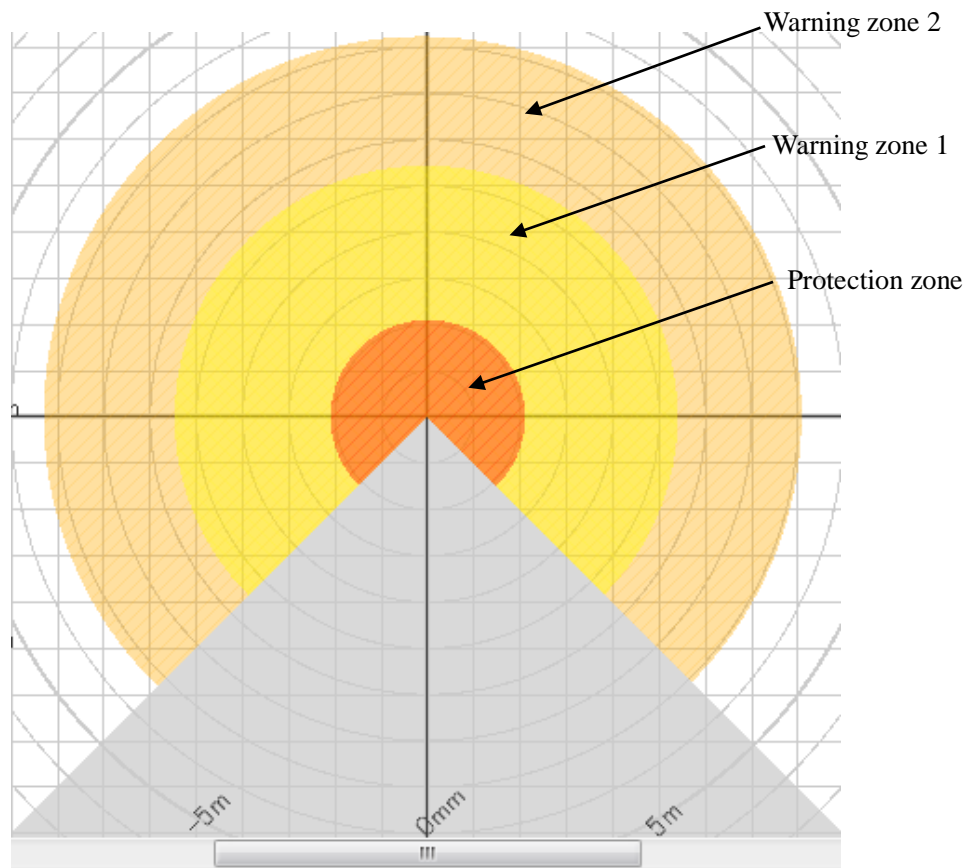

Figure 3-4 Scanning range

Figure 3-4 shows the scanning range of UAM. Protection zone and warning zones are configured using the UAM Project Designer application software. Any object or human beings entering the protection zone will lead the OSSD signal to change from ON-state to OFF-state. Similarly, an object detected in the warning zones will lead the warning signals to change to OFF-state.

Distance to the object is measured using the Time of Flight (TOF) principle. Pulsed laser beams are radiated into the scanning range of 270° by the rotating motor. These pulsed laser beams are reflected back by objects inside the scanning range. The duration of reflected beams are used for distance calculation as shown below:

$$L = \frac{1}{2} \times C \times T$$

Where, L=Distance of the object
C=Speed of the light
T=Time difference

The operating principle of TOF is schematically shown in Figure 3-5. The angular resolution of UAM is

0.125°.

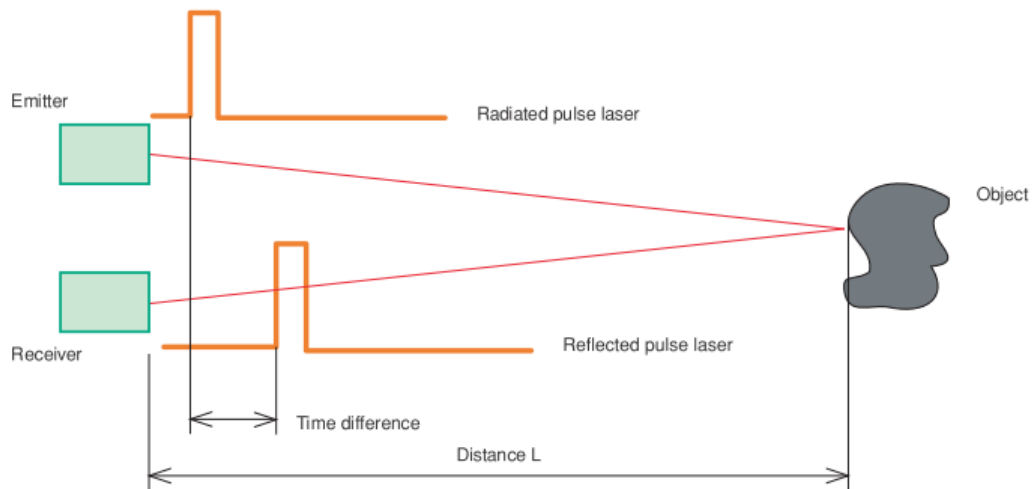

Figure 3-5 TOF operation principle

3.4 Scanning area

Scanning area of UAM consists of protection zone and warning zones. Maximum 32 sets of area can be configured. Further, two combinations for protection and warning zones can be selected for the operation.

Combination 1: Protection zone, Warning zone 1 and Warning zone 2

Combination 2: 2 Protection zones (Dual Protection)

In dual protection mode, two protection areas can be configured but it is not possible to configure the warning zones. Protection and warning zones can be configured by using UAM Project Designer. Refer to Chapter 7 for configuration details.

3.4.1 Protection zone

Protection zone is safety-critical and directly connected to the OSSD signal. When an obstacle is detected in the protection zone, UAM will switch the OSSD to OFF-state (which should trigger a switch to stop a machine or AGV). For mobile applications, the OSSD signal can be used as the emergency stop signal. Figure 3-6 and 3-7 show the examples of protection zone configured using manual mode and teaching mode respectively. User can configure these zones accordingly to ensure hazardous area is completely protected.

In dual protection mode, two protection zones can be configured independently. UAM will monitor these zones simultaneously. OSSD1 and OSSD2 are dedicated to protection zone1 and OSSD3 and OSSD4 are dedicated to protection zone2.

Figure 3-8 shows an example of the dual protection zone configuration. Warning zones cannot be configured in dual protection mode.

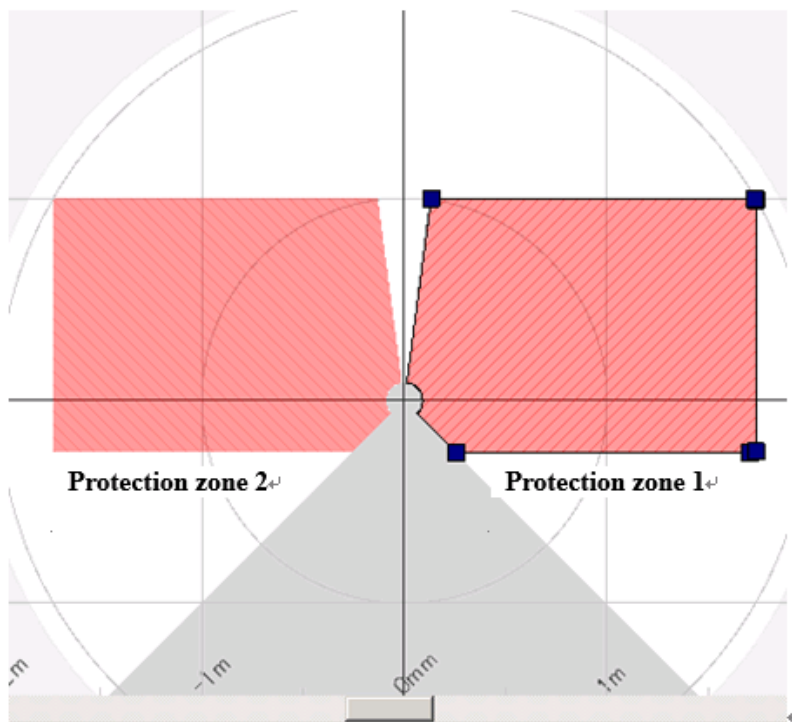

Figure 3-8 Example of Dual protection zone configuration

3.4.2 Warning zone

Warning zones are non-safety zones and are connected to Warning1 and Warning2 outputs. When the obstacle is detected in the warning zones, UAM will switch the respective warning signal from ON-state to OFF-state.

Warning signals can be used as an alert signal to avoid human beings or objects from approaching near the protection zone. For mobile applications, warning signals can be used for reducing the speed of automatic guided vehicle (AGV) to avoid collision. Figure 3-9 shows an example of warning zone configuration.

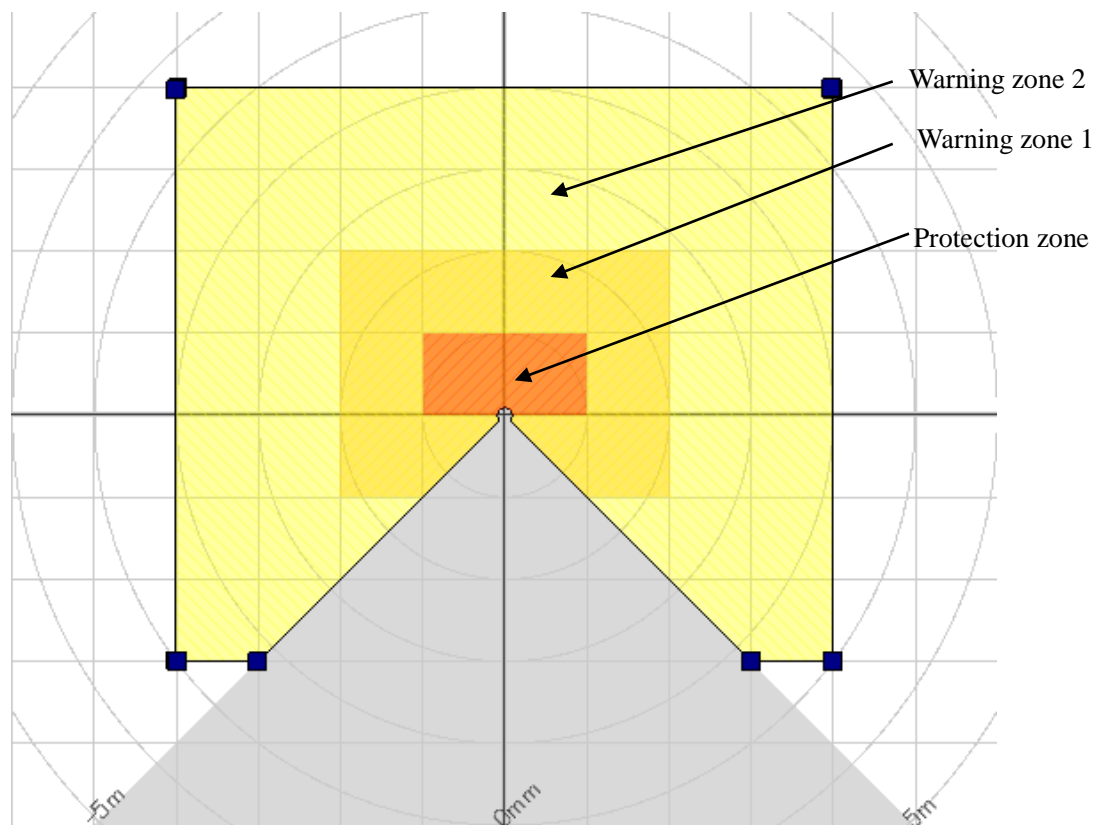

Figure 3-9 Warning zones



Danger

- Warning zones are non-safety zones.
- Warning signals should not be used for controlling any machine or vehicle for the safety-related purposes.



Caution

- Warning signals are non safety-signal.
- Warning signals and OSSD signal is not inter-related.

3.5 Area switching

A maximum of 32 sets of area can be configured in UAM. However the maximum configurable area number differs depending on the selected function such as, muting and dual protection. Table 3-1 shows the maximum configurable area number according to the used mode.

External input signals are provided in UAM for switching the area. Each signal has a pair of normal and inverted signal. For example, it is necessary to provide both input signal **IN_A** and inverse **IN_A** signal to switch the area. Error will occur if **IN_A** and inverse **IN_A** signals do not complement each other. Table 3-2 below shows the combination of input signal to switch the area. Area in use will be displayed in the 7 segment LED of UAM.

It is also possible to configure area input delay. Configure the necessary delay required for the system to provide stable input signals to UAM. The default value is 30ms.



There are maximum 5 input pairs (a pair is combination of normal and inverted signal) in UAM therefore, it can operate with maximum 32 sets of area. Further, it is also possible to switch the area through the speed monitoring of incremental encoder signal connected to UAM (📄 page 24). Maximum configurable area in encoder input mode is 128.

Table 3-1 Input combination for area switching

Mode	Protection	Max internal input	Max Area	Max encoder area
Standard	1	5	32	—
	2	5	32	—
EDM	1	4	16	—
	2	4	16	—
MUTING / EDM	1	2	4	—
	2	1	2	—
Encoder ^{*1}	1	3	7	128 ^{*2}
	2	3	7	128 ^{*2}

*1: Muting function cannot be used if encoder input mode is selected.

*2: Among the 8 input patterns, at least one pattern must be assigned for encoder input. Other 7 remaining patterns can be assigned to be used as static input, encoder input or not in use. A pattern with encoder input mode can have maximum 128 sets of area (see section 3.6.4 for the details).

Table 3-2 Input combination for area switching

a) In the case of 5 input signals

Area	IN_A	IN_B	IN_C	IN_D	IN_E	IN_Ā	IN_Ḃ	IN_Ĉ	IN_Ḋ	IN_Ē
Area 1	ON	ON	ON	ON	ON	OFF	OFF	OFF	OFF	OFF
Area 2	OFF	ON	ON	ON	ON	ON	OFF	OFF	OFF	OFF
Area 3	ON	OFF	ON	ON	ON	OFF	ON	OFF	OFF	OFF
Area 4	OFF	OFF	ON	ON	ON	ON	ON	OFF	OFF	OFF
Area5	ON	ON	OFF	ON	ON	OFF	OFF	ON	OFF	OFF
Area6	OFF	ON	OFF	ON	ON	ON	OFF	ON	OFF	OFF
Area7	ON	OFF	OFF	ON	ON	OFF	ON	ON	OFF	OFF
Area8	OFF	OFF	OFF	ON	ON	ON	ON	ON	OFF	OFF
Area9	ON	ON	ON	OFF	ON	OFF	OFF	OFF	ON	OFF
Area10	OFF	ON	ON	OFF	ON	ON	OFF	OFF	ON	OFF
Area11	ON	OFF	ON	OFF	ON	OFF	ON	OFF	ON	OFF
Area12	OFF	OFF	ON	OFF	ON	ON	ON	OFF	ON	OFF
Area13	ON	ON	OFF	OFF	ON	OFF	OFF	ON	ON	OFF
Area14	OFF	ON	OFF	OFF	ON	ON	OFF	ON	ON	OFF
Area15	ON	OFF	OFF	OFF	ON	OFF	ON	ON	ON	OFF
Area16	OFF	OFF	OFF	OFF	ON	ON	ON	ON	ON	OFF
Area17	ON	ON	ON	ON	OFF	OFF	OFF	OFF	OFF	ON
Area18	OFF	ON	ON	ON	OFF	ON	OFF	OFF	OFF	ON
Area19	ON	OFF	ON	ON	OFF	OFF	ON	OFF	OFF	ON
Area20	OFF	OFF	ON	ON	OFF	ON	ON	OFF	OFF	ON
Area21	ON	ON	OFF	ON	OFF	OFF	OFF	ON	OFF	ON
Area22	OFF	ON	OFF	ON	OFF	ON	OFF	ON	OFF	ON
Area23	ON	OFF	OFF	ON	OFF	OFF	ON	ON	OFF	ON
Area24	OFF	OFF	OFF	ON	OFF	ON	ON	ON	OFF	ON
Area25	ON	ON	ON	OFF	OFF	OFF	OFF	OFF	ON	ON
Area26	OFF	ON	ON	OFF	OFF	ON	OFF	OFF	ON	ON
Area27	ON	OFF	ON	OFF	OFF	OFF	ON	OFF	ON	ON
Area28	OFF	OFF	ON	OFF	OFF	ON	ON	OFF	ON	ON
Area29	ON	ON	OFF	OFF	OFF	OFF	OFF	ON	ON	ON
Area30	OFF	ON	OFF	OFF	OFF	ON	OFF	ON	ON	ON
Area31	ON	OFF	OFF	OFF	OFF	OFF	ON	ON	ON	ON
Area32	OFF	OFF	OFF	OFF	OFF	ON	ON	ON	ON	ON

b) In the case of 4 input signals

Area	IN_A	IN_B	IN_C	IN_D	IN_Ā	IN_B̄	IN_C̄	IN_D̄
Area 1	ON	ON	ON	ON	OFF	OFF	OFF	OFF
Area 2	OFF	ON	ON	ON	ON	OFF	OFF	OFF
Area 3	ON	OFF	ON	ON	OFF	ON	OFF	OFF
Area 4	OFF	OFF	ON	ON	ON	ON	OFF	OFF
Area5	ON	ON	OFF	ON	OFF	OFF	ON	OFF
Area6	OFF	ON	OFF	ON	ON	OFF	ON	OFF
Area7	ON	OFF	OFF	ON	OFF	ON	ON	OFF
Area8	OFF	OFF	OFF	ON	ON	ON	ON	OFF
Area9	ON	ON	ON	OFF	OFF	OFF	OFF	ON
Area10	OFF	ON	ON	OFF	ON	OFF	OFF	ON
Area11	ON	OFF	ON	OFF	OFF	ON	OFF	ON
Area12	OFF	OFF	ON	OFF	ON	ON	OFF	ON
Area13	ON	ON	OFF	OFF	OFF	OFF	ON	ON
Area14	OFF	ON	OFF	OFF	ON	OFF	ON	ON
Area15	ON	OFF	OFF	OFF	OFF	ON	ON	ON
Area16	OFF	OFF	OFF	OFF	ON	ON	ON	ON

c) In the case of 3 input signals

Area	IN_A	IN_B	IN_C	IN_Ā	IN_B̄	IN_C̄
Area 1	ON	ON	ON	OFF	OFF	OFF
Area 2	OFF	ON	ON	ON	OFF	OFF
Area 3	ON	OFF	ON	OFF	ON	OFF
Area 4	OFF	OFF	ON	ON	ON	OFF
Area5	ON	ON	OFF	OFF	OFF	ON
Area6	OFF	ON	OFF	ON	OFF	ON
Area7	ON	OFF	OFF	OFF	ON	ON
Area8	OFF	OFF	OFF	ON	ON	ON

d) In the case of 2 input signals

Area	IN_A	IN_B	IN_Ā	IN_B̄
Area 1	ON	ON	OFF	OFF
Area 2	OFF	ON	ON	OFF
Area 3	ON	OFF	OFF	ON
Area 4	OFF	OFF	ON	ON

e) In the case of 1 input signal

Area	IN_A	IN_Ā
Area 1	ON	OFF
Area 2	OFF	ON

3.6 Incremental encoder

In UAM there are 2 pairs of encoder input terminals for connecting 2 units of dual channel incremental encoder signals. Area will be switched depending on the encoder speed. Direction of travel is detected by encoder's phase A and phase B signals having the phase difference of 90°. Speed and rotating direction of both encoders are constantly monitored to detect abnormal travel and stop the AGV.

Incremental encoder output signals should be connected to the respective input terminals of UAM. There are two patterns of signals generated by the combination of Phase A and Phase B of encoders depending on the direction of travel (Figure 3-10). In the first pattern, Phase B is 90 degrees ahead of Phase A wherein, at the rising edge of Phase A, state of Phase B is "H". This pattern is considered as positive direction (forward motion). In the second pattern, Phase B lags behind Phase A by 90 degrees and the state of Phase B at the rising edge of Phase A is "L". This is considered as negative direction (backward motion).

Direction of Travel: Forward

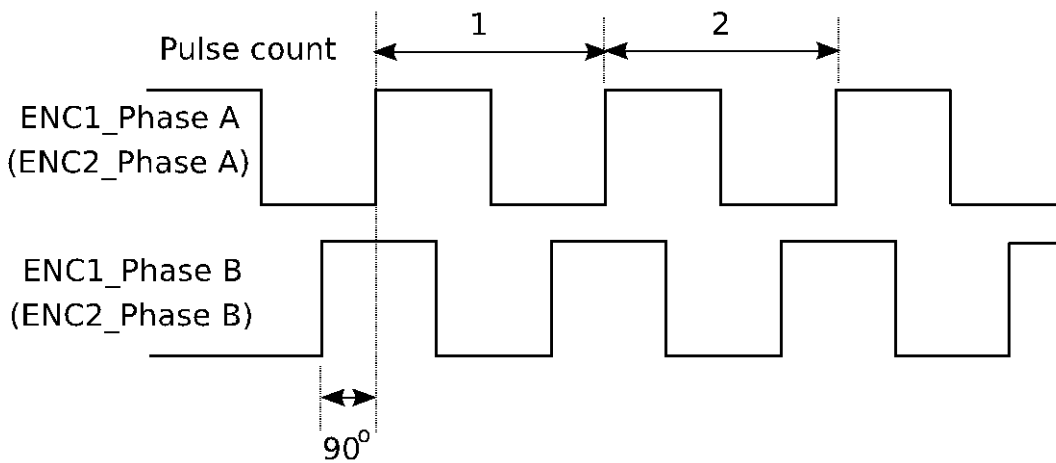

Direction of Travel: Backward

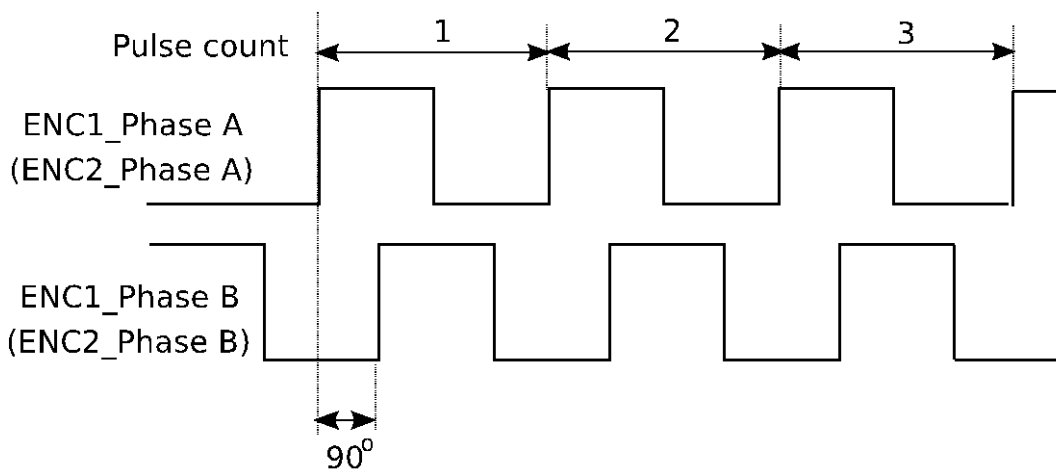

Figure 3-10 Input signals from incremental encoder

3.6.1 Pulse per cm travel generated by incremental encoders

When AGV travels, incremental encoder generates pulses due to the transmission ratio between AVG tires and incremental encoder frictional wheel. Pulse count per cm depends on AGV's speed.

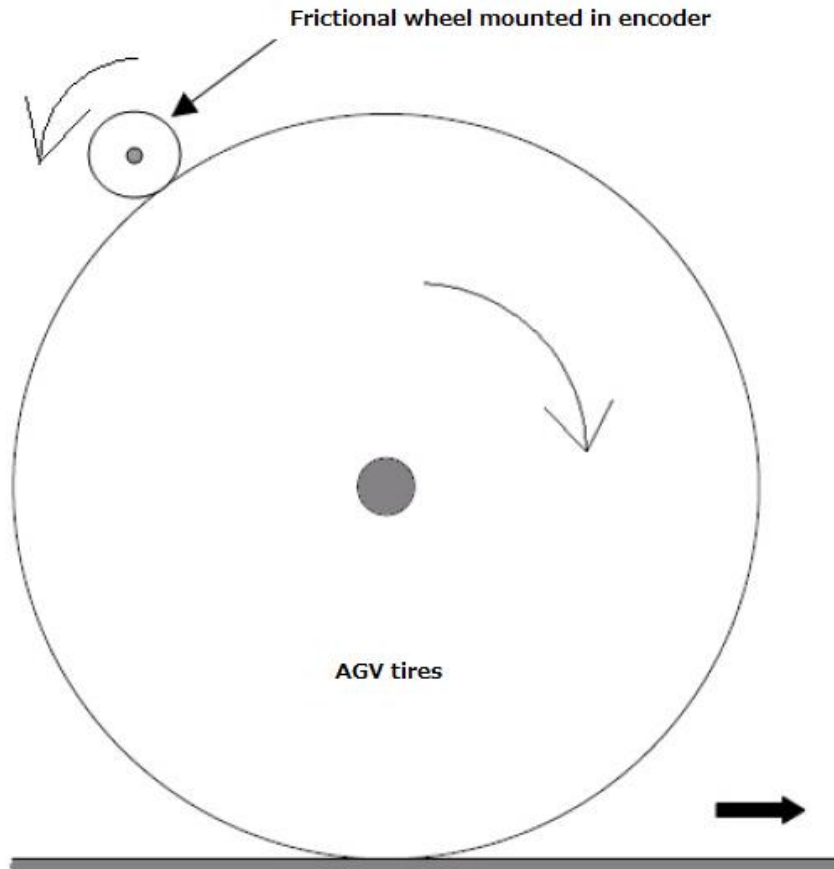

Figure 3-11 Calculation of pulse count per centimeter travel

- AGV tire diameter: 40 cm
- Frictional wheel diameter mounted in incremental encoder: 5 cm
- Incremental encoder pulse number per revolution: 1000 pulse

AGV tire circumference = Diameter \times Circumference ratio = 40 cm \times 3.14 = 125.6 cm

AGV tire's one rotation is equivalent to 8 rotations of frictional wheel. This equals to the 8,000 pulses of incremental encoder.

From above, incremental encoder pulse count per cm is obtained as

$$8,000/125.6 = 63.7$$

While setting encoder parameters (Encoder Pulse1 and Encoder Pulse2) in UAM project Designer, set the encoder pulse count after rounding the calculated value to nearest whole number (64 in this case)

In the explanation above, the transfer method of the rotation was based on the frictional wheel. Same

method can be applied for other cases to estimate the pulse count generated for one rotation of the wheel.



Caution

- User should verify the proper area switching through encoder inputs.
- Always use 2 units of incremental encoder. It is not possible to detect the failure of incremental encoder or abnormal travel of the vehicle with single unit.
 - Use separate sets of cable to connect outputs from incremental encoder 1 and 2 to the respective encoder input terminals of UAM.
- Separate the power supply cables and power source of each incremental encoder. Output pairs of Encoder connection should match the input pair of UAM.
- Do not wire other power lines parallel to encoder and UAM or wire in the same duct. There is a possibility of noise disturbance.

3.6.2 Recommend incremental encoder specification

- Phase setting 90° dual channel rotary encoder
- Power supply: DC 24V
- Output : Complementary output
- Protective class : IP 54 or more
- Output cable : Twist pair/ shield cable
- Maximum pulse frequency : 100 kHz
- Minimum pulse frequency : 50 pulse/cm

3.6.3 Tolerances allowed for encoder

When AGV travels in a forward direction, speed input through the two incremental encoders will be same as the original pulse frequency. However, there are cases when two speed input values may differ, such as while cornering and due to AGV tire exhaustion. The difference between two input speeds should not exceed the error tolerance for more than a fixed period of time. Set the error tolerance in the range of 0 to 80%. Of the two speeds, the larger value will be considered for vehicles speed calculation. When permitted error tolerance exceeds the fixed period OSSD will go to OFF state. Tolerance period differs according to the vehicle speed as shown in table 3-3.



Table 3-3 Relation between AVG speed and tolerance

AGV speed v (cm/s)	Tolerance
$-9 \leq v \leq +9$	Infinity
$-30 < v < -9$ or $9 < v < 30$	60s
$v \leq -30$ or $+30 \leq v$	20s
$v < -9$ or $+9 < v$ (Two encoders with different rotating direction)	0.3s

3.6.4 Area switching by encoder input

When encoder setting is enabled, four patterns can be selected from two available external inputs. For each pattern, select either to use as static input or the encoder input or not in use. It is necessary to select at least one pattern for encoder input.

Further, patterns can be increased to 8 patterns by activating the “8 patterns (Input E Enable)” checkbox.

For the patterns assigned to encoder input, a maximum 128 sets of area switching can be performed for the range of speed. Following detailed settings of the encoder function is done by the UAM project designer. For using the UAM Project Designer refer to chapter 7.

Set the error tolerance and encoder pulse count for per cm travel. The minimum and maximum speed is automatically calculated from the pulse count and maximum pulse frequency (100 kHz).

Next, select the input patterns to use as static input or for the encoder input or not used. Figure 3-12 shows an example of encoder input setting. In this example, pattern 1 and pattern 2 are used as static input, pattern 3 is used as encoder input and pattern 4 is not used.

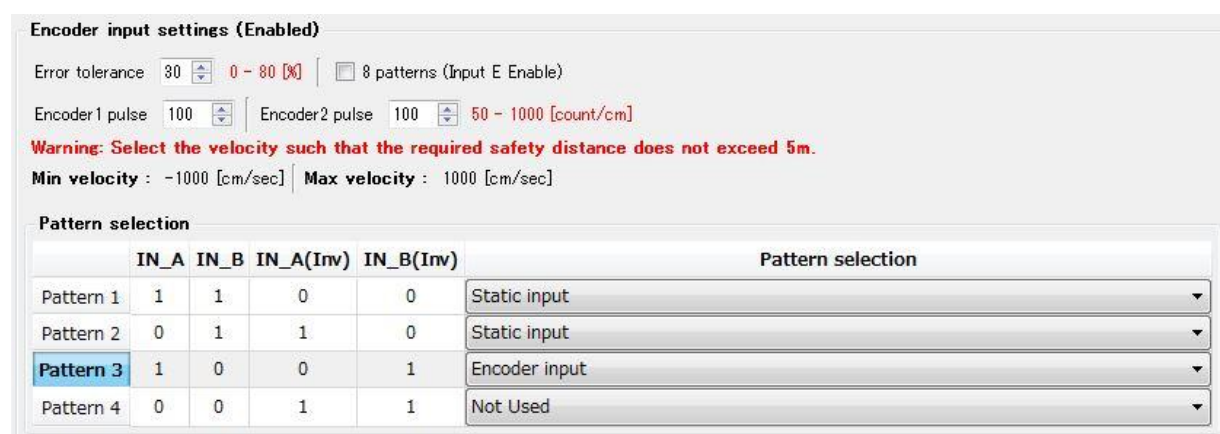

Figure 3-12 Example of pattern switching through encoder input

Next, divide the speed into number of ranges and specify the area number for each range. An example is shown below (maximum 128 sets of area can be set). Same area cannot be specified for different speed within a pattern. However, it is possible to select same area for a different pattern.

Figure 3-13(a) shows the example of encoder input setting. In this example, speed is divided into 4 ranges and each speed range is assigned Area 3 to Area 6.



Danger

- OSSD is a safety related signal and should be connected directly to the relay or device that switches the machine or vehicle under control.
- Sufficient time for the machine or vehicle must be allocated to stop when configuring the response time of OSSD.
- Both the OSSD1 and OSSD2 outputs should be connected to the safety related machines or control system. If OSSD3 and OSSD4 are used they must be connected similarly.
- User must verify the configuration before actual operation.

Note ● When OSSD is at ON state, the signal is 24V and the signal is 0V during OFF state.

3.7.1 Self-diagnostic function of OSSD

Self-diagnostic is a function to detect the malfunction in the output circuit by switching OFF the OSSD1 to OSSD4 for an interval of 300 μ s. Therefore, safety-relay or power converter used must not response to this diagnostic function. Figure 3-14 below shows the timing chart of the self diagnostic function of the OSSD during dual protection mode.

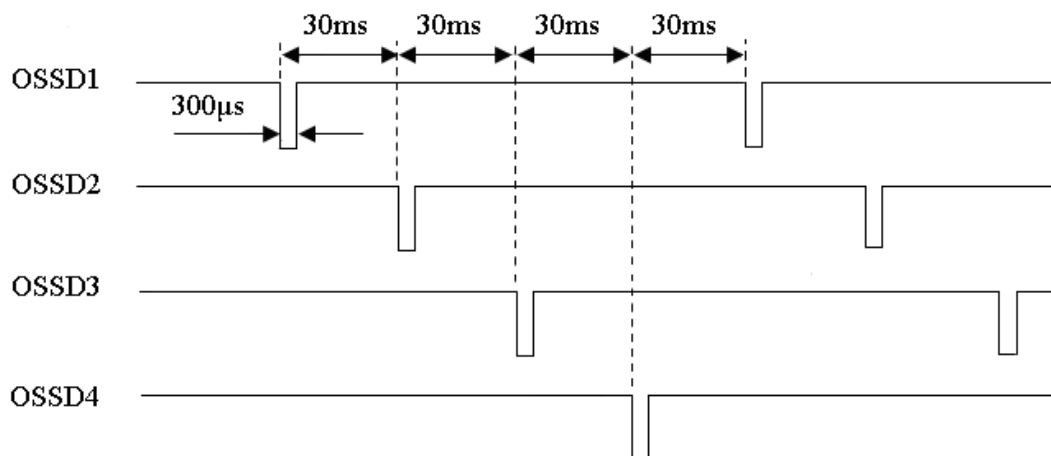

Figure 3-14 Timing chart of the OSSD's self-diagnostic function

In single protection mode, self-diagnostic function is done for OSSD1 and OSSD2 signals only.

3.7.2 Lockout state

When an error is detected by the self-diagnostic function and UAM cannot operate normally it will switch to lockout state. During the lockout state, OSSD1/2, OSSD3/4, WARNING1, WARNING2 will switch to OFF-state. After removing the error, UAM can be reset by restoring the power to release from the lockout state.



3.7.3 Interlock function

Interlock is a function to prevent automatic restart of the OSSD signal switching from OFF-state to ON-state. Automatic restart, manual restart and manual start interlock functions are configurable using the UAM Project Designer.

3.7.3.1 Automatic restart

UAM will restart automatically when interlock function is disabled or only the start interlock function is enabled. When obstacle from the protection zone is removed, OSSD signals switch from OFF-state to ON-state automatically. OSSD response times for ON and OFF states are configurable (See section 3.12). However, if UAM is in the lockout state due to error, OSSDs will remain in OFF-state even if the interlock function is disabled.

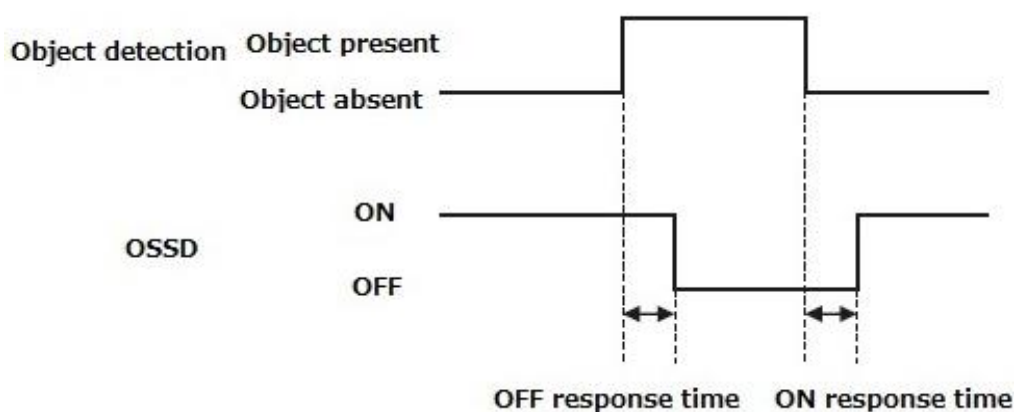

Figure 3-15 Timing chart of automatic restart



Danger

- In automatic restart configuration OSSD will automatically switch to ON state after the object is removed. Confirm the safety while removing the object.
- Configured response time should be sufficient for the machine or AGV to stop safely.

3.7.3.2 Manual restart (Interlock enabled)

UAM operates in manual restart mode when interlock function is set to manual mode. The OSSD signal switches from ON-state to OFF-state, if UAM detects any obstacle within the protection zone or detects any system error. In this mode, even if the detected obstacles or system error is removed, OSSD signals will remain in OFF-state. An external reset input signal is required to release the interlock which allows the UAM to switch to normal operation.

UAM will resume normal operation only after confirming the reset signal (RESET). The duration of the reset signal should be more than 500ms. Figure 3-16 shows the timing chart of the manual restart. After reset



signal is confirmed, the OSSD signal will switch to ON-state after the lapse of the configured delay time. . If OSSD's OFF-state is due to an internal fault, it will remain in OFF-state even when reset signal is provided. Reset delay is configurable in the range of 1s to 6s.

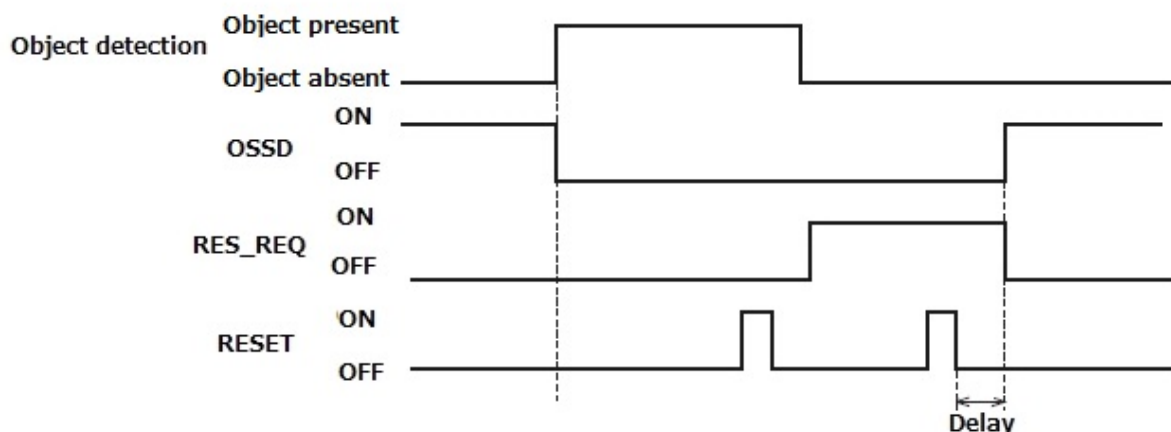

Figure 3-16Timing chart of manual restart



Danger

- User should verify that the detected obstacle is safely removed before resetting the UAM.
- If restart interlock function is used to restart the machine, the reset switch should be mounted away from the protection zone.
- Falling to comply with the above could lead to critical injury or death.

Note

- Even after the object is removed from the protection zone, if the OSSD still remains in OFF-state, check the error code and suggested solution (Refer to Chapter 9)
- Duration of reset input should not exceed 30s; otherwise it will be detected as hardware malfunction.

3.7.3.3 Manual start (Interlock enabled)

Start interlock is a function which keeps the OSSD in OFF-state during the start-up until an external reset input is applied. Start interlock setting has only manual mode. The RES_REQ signal switches to ON-state after the UAM completes initial routines and ready to accept the RESET input. When RESET input is applied, OSSD will switch to ON state if no object is detected in the protection zone. The duration of the reset input should be more than 500ms. Figure 3-17 shows the sequence of start interlock. Delay can be configured in the range of 1s to 6s.



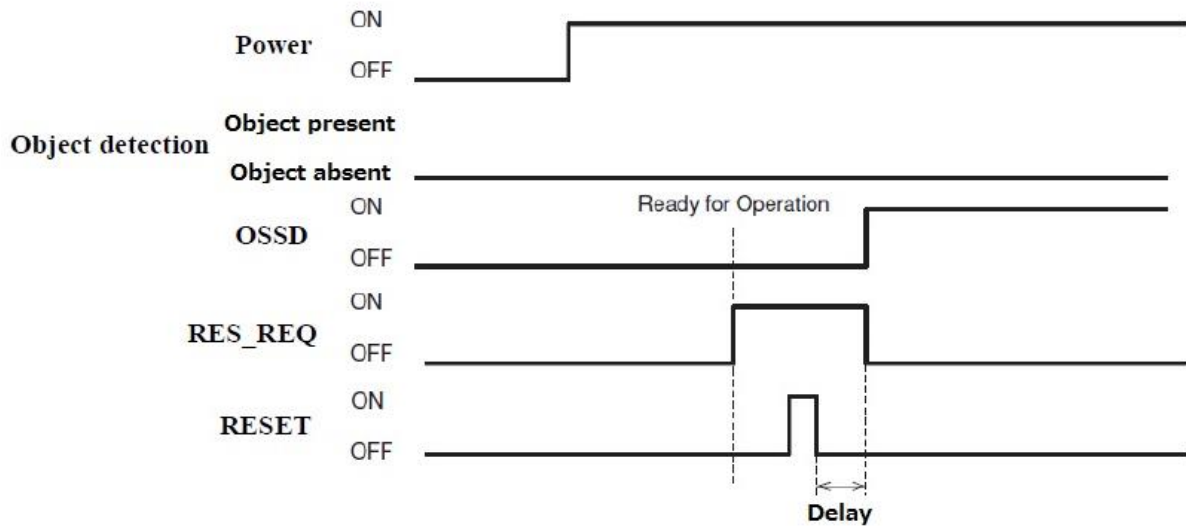

Figure 3-17 Manual start sequence

3.8 External device monitoring (EDM) function

EDM is a function that monitors the state of the input signal from the controlled machine or automated guided vehicle (AGV). EDM is configured using the UAM project designer. When EDM function is enabled, any fault detected in EDM signal will switch the OSSD signal to OFF-state. Logic of EDM signal should be always inverse of the OSSD signal. EDM input signal ON/OFF delay is configurable to match the user's system. Figure 3-18 and 3-19 below shows the EDM circuit and EDM timing chart respectively.

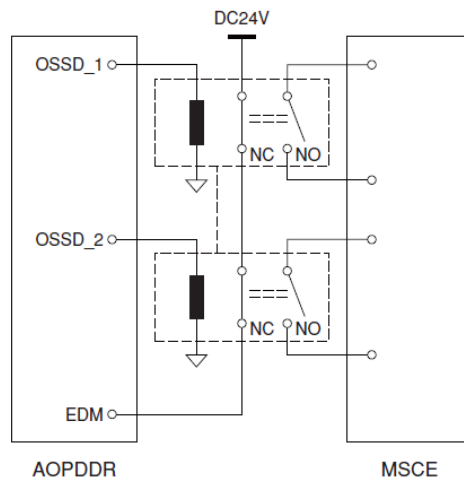

Figure 3-18 EDM circuit

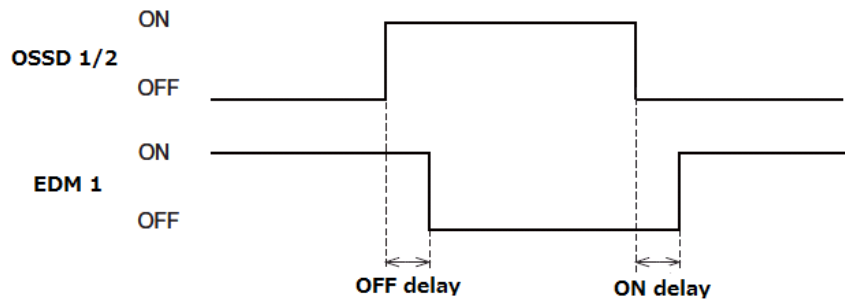

Figure 3-19 EDM timing chart

In dual protection mode, EDM2 circuit and timing chart for OSSD3 and OSSD4 are same as above.

3.9 Muting function

Muting function temporarily suspends the safety function in the configured zone of UAM when the specified conditions are fulfilled. In the muting state OSSD remains in the ON-state even when an object is detected in the configured muting zone. Two independent hard wired input signals are provided to start and end the muting function. Muting zone is configured using the UAM project designer (Refer to section 7.9.1). When muting inputs fulfill the muting start conditions, UAM will suspend the safety function within 60ms and resume the safety function if they fulfill the muting stop conditions.

3.9.1 Muting start condition

Muting function will start when the following conditions are fulfilled:

- a) There are no objects in the protection zone and the OSSD is in ON-state.
- b) The two independent hard wired muting input signals are switched to ON state in the predefined sequence within the pre-set time interval. However, the switching interval between two input signals should be at least 30ms delay between the signals (Refer to figure 3-20).

The following configurations are necessary for the muting function. User can configure these by using the UAM project designer.

- Muting inputs sequence
 - ▶ Muting 1 → Muting 2
 - ▶ Muting 2 → Muting 1
- Time interval between two inputs (T1)
 - ▶ 1second
 - ▶ 3seconds
 - ▶ 5seconds
 - ▶ 10seconds



When using muting function in dual protection mode, Muting 3 and Muting 4 are configured in the similar way.

3.9.2 Muting stop condition

Muting function will stop when any one of the condition below is fulfilled:

- a) One of the muting inputs switches to OFF-state.
- b) When the predefined (preset) maximum muting time T2 exceeds (1 minute and above) (Figure 3-20).
- c) Objects are detected in the protection zone which is not covered by the muting zone.
- d) Error is detected by the self-diagnostics function.
- e) During muting state when the area is switched to other area.

Figure 3-20 shows the muting sequence.

- Maximum muting period (T2)

Maximum muting period can be selected from one of these values

- ▶ 1 minute
- ▶ 6 minutes
- ▶ 12 minutes
- ▶ Unlimited

When using the muting function in dual protection mode, Muting 3 and Muting 4 are configured in the similar way. Same applies for muting input sequence, time interval between inputs and maximum muting period.

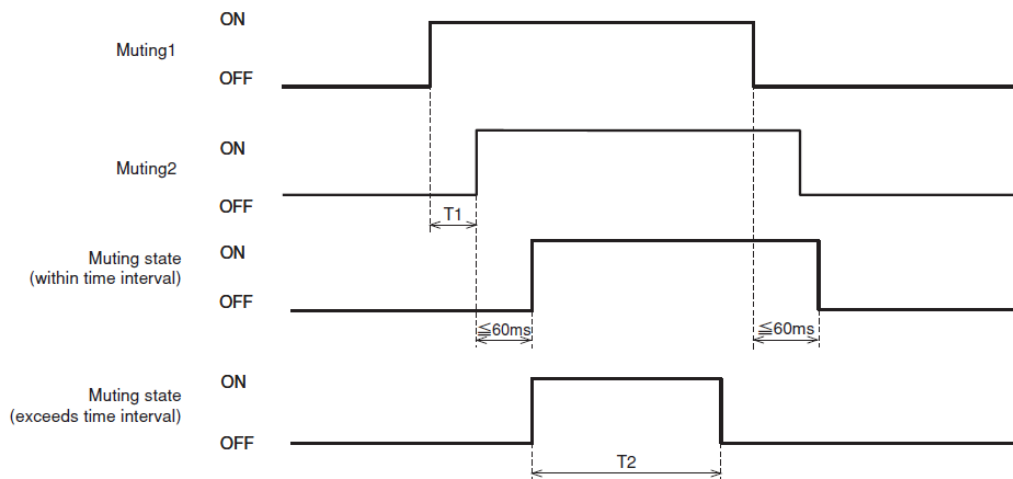

Figure 3-20 Muting sequence

3.9.3 Muting override function

Muting override is a function to recover UAM when the OSSD is switched to OFF state due to muting related errors by temporarily suspending the safety function. Override function is active when the override input (OVERRIDE 1/2) and the reset input (RESET 1/2) are switched in a sequence. Figure 3-21 shows the override sequence.

- **Override start conditions**
 - ▶ At least one of the muting inputs is in ON-state.
 - ▶ Object is present in the protection zone.
 - ▶ Time interval between override input and reset input is within 0.03s to 1s (T3).

- **Override stop conditions**
 - ▶ Both muting inputs are in OFF-state.
 - ▶ Override input or reset input is in OFF-state.
 - ▶ When predefined maximum override time T4 exceeds.
 - ▶ Error is detected by self-diagnostic function of the UAM.
 - ▶ During override state when area is switched to the other area.

- **Maximum override period (T4)**
 Maximum override period can be selected from one of these values
 - ▶ 1 minute
 - ▶ 6 minutes
 - ▶ 12 minutes

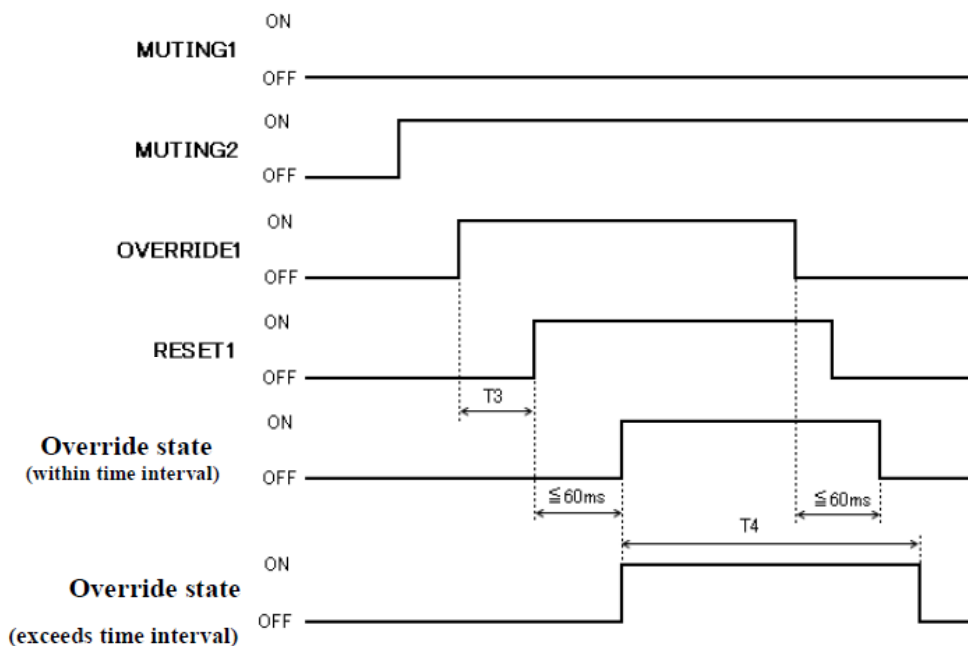

Figure 3-21 Override Sequence

When using muting override in dual protection mode, Muting 3, Muting 4, Override input 2 and Reset

input 2 are configured in the similar way.



Danger

- When muting function is enabled, user must ensure the safety of the protection zone.
- Before using the muting function, user must perform risk assessment.
- A qualified person should configure the appropriate muting period according to the requirement of the application. It is the user's responsibility to properly perform the risk assessment when configuring muting period to unlimited.
- Failing to comply with the above could lead to critical injury or death.

3.10 Reference monitoring function

Reference monitoring is a function to monitor the displacement of the UAM or the structure used as reference boundary.

3.10.1 Area protection

An example of reference monitor function used for area protection is shown in figure 3-22. If reference segments are configured on moveable objects (example: door) the OSSD will switch to OFF-state when the door position is changed.

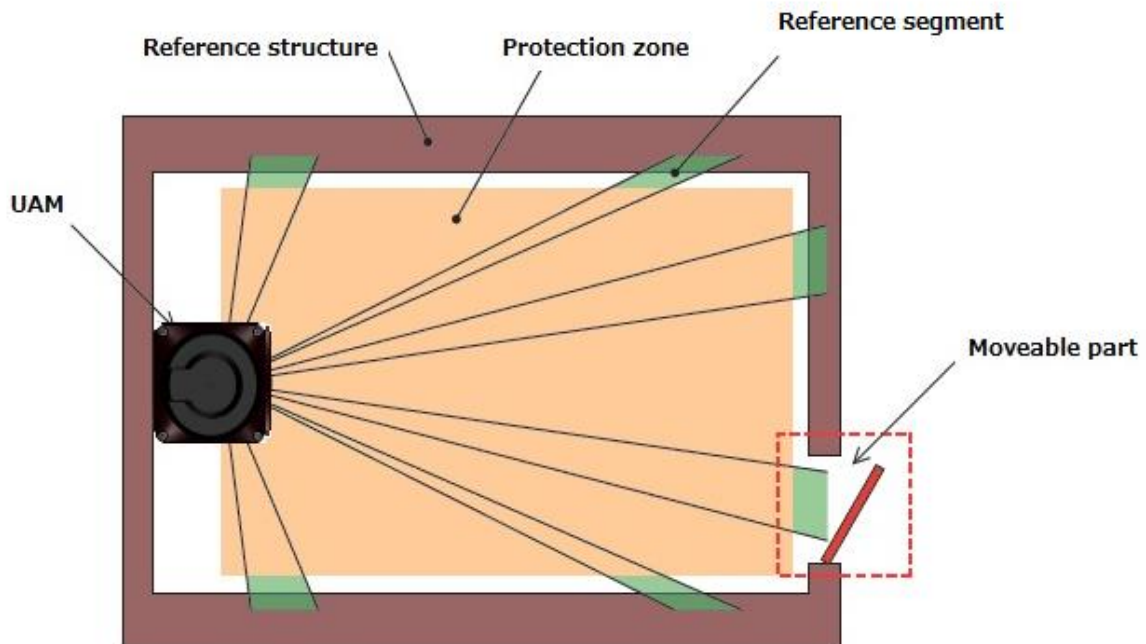

Figure 3-22 Top view of the area protection using reference monitor function



3.10.2 Access protection

An example of reference monitor function used for access protection is shown in figure 3-23(a), (b). Reference segments should be configured on each surface for displacement detection. Reference segments should be configured such that displacement can be easily detected. The OSSD will switch to OFF-state when access penetration is detected, and also if the distance between UAM and the reference structure changes. This function is compulsory for vertical applications.

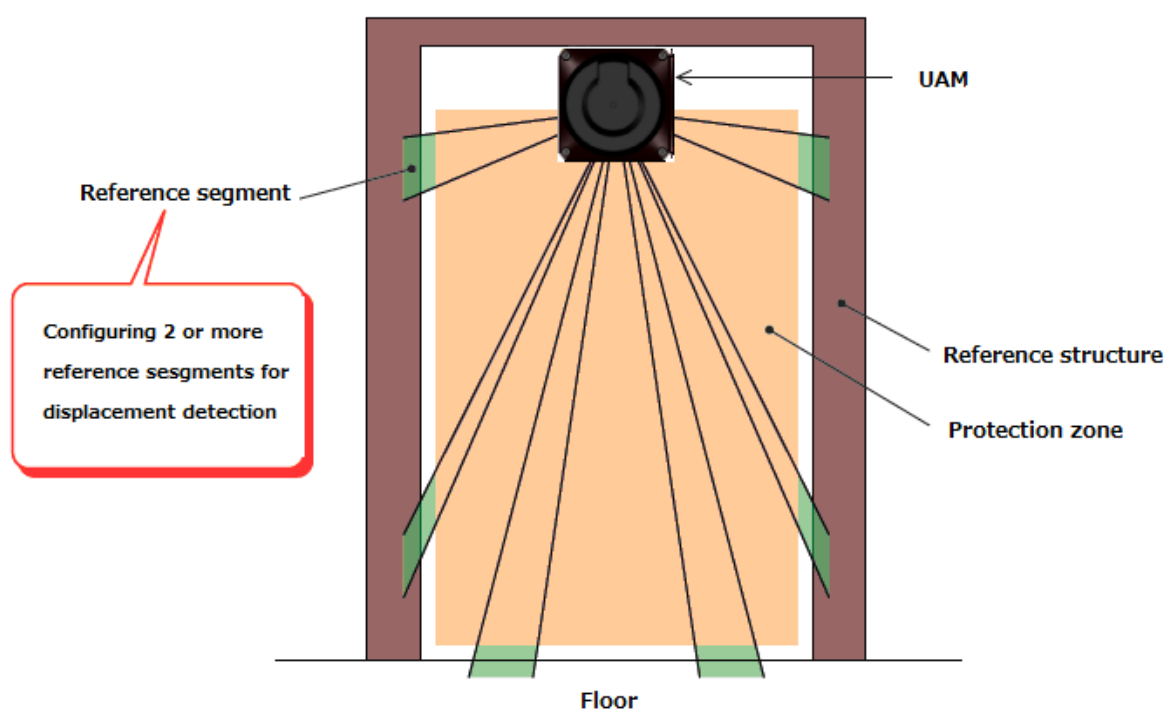

Figure 3-23 (a) Front view of the access detection using reference monitor function

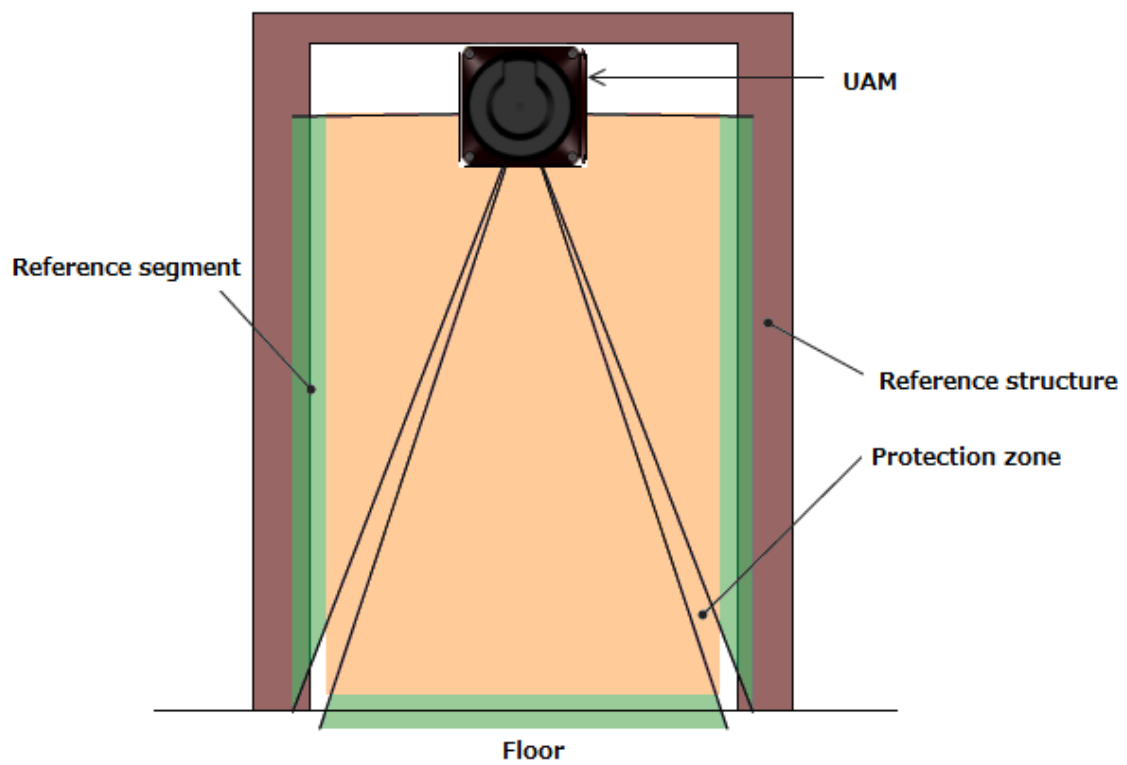

Figure 3-23 (b) Front view of the access detection using reference monitor function

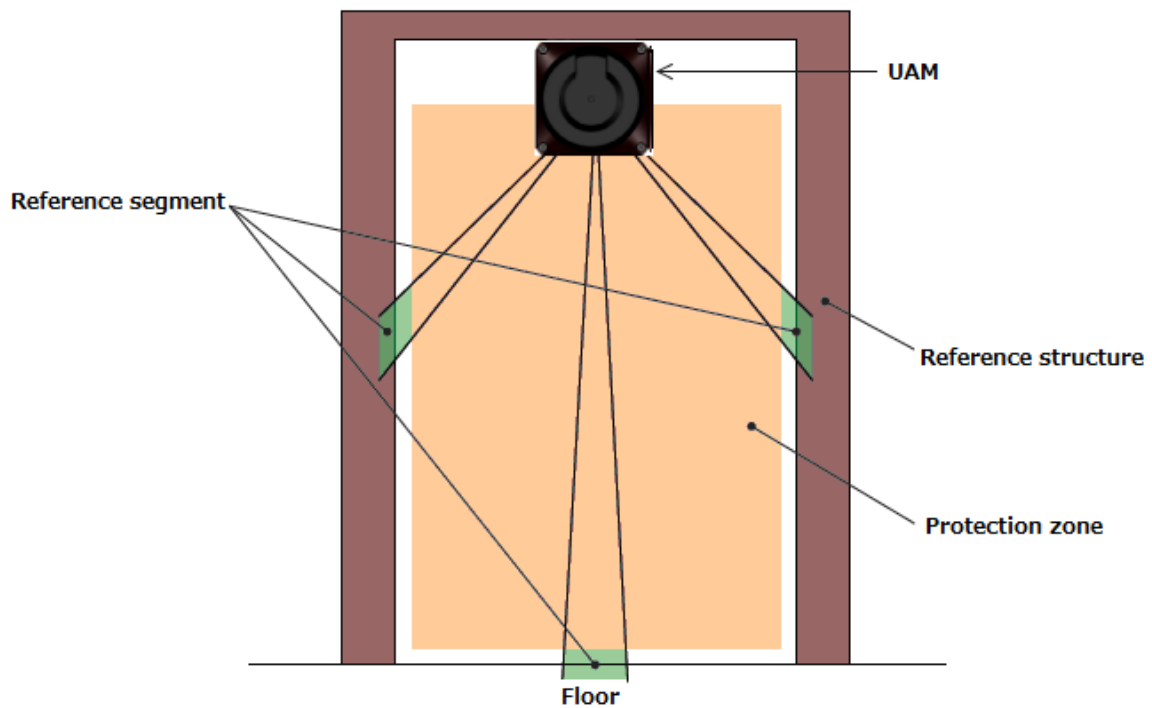

Figure 3-23(c) Incorrect configuration of reference segment

3.11 Area sequence function

Area sequence is a function to monitor sequences of area switching. When this function is activated, OSSD signal will switch to OFF-state if the switching pattern is other than the configured sequence. This function prevents the machine to operate with random protection zone.

From each area, switching selection to maximum 31 other areas is possible when configuring the area sequence. And, it is necessary to specify 1 or more areas to avoid error.

<Area switching sequence>

When area sequence is disabled, UAM can switch from an area to any other areas (Figure 3-24(a)) whereas it can only switch to specified areas if area sequence is enabled. (Figure 3-24(b)).

Area sequence function is recommended for control systems where switching area sequences can be configured.

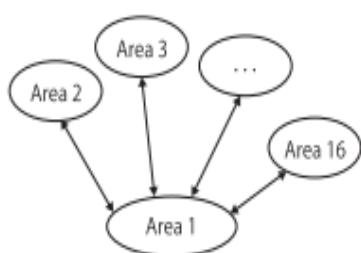

Figure 3-24(a) Operation without area sequence

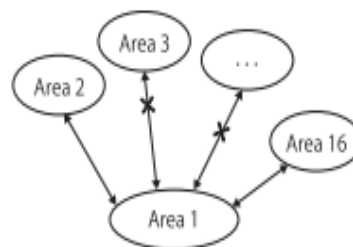

Figure 3-24(b) Operation with area sequence

3.12 Response time

Response times of OSSD signal (Figure 3-25), OFF response time and ON response time (default 270ms) are configurable individually for each area using the UAM project designer. Response time of the Warning 1 and Warning 2 will be same as the OSSD response time. Table 3-4 shows the possible configurable values. In the dual protection mode, it is possible to set a separate response time for each protection area.

When longer response time is configured, the stability of UAM can be increased. However, longer response time requires longer safety distance. (Refer to chapter 4). User must perform risk assessment before configuring the response time. Addition of maximum 1 cycle (30ms) has to be taken into account for the area switching.

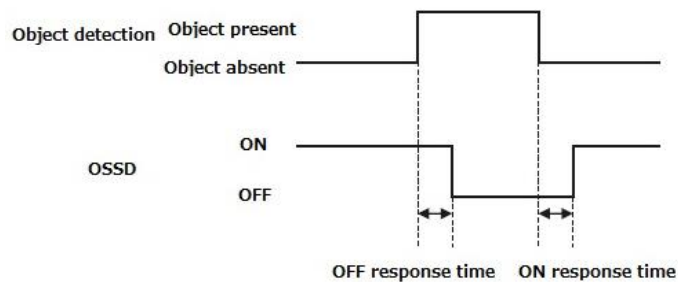

Figure 3-25 Response time

Table 3-4 Response time of UAM

OFF	Response time (ms)							
	60	90	120	150	180	210	240	270
	300	330	360	390	420	450	480	510
	540	570	600	630	660	690	720	750
	780	810	840	870	900	930	960	990
	1020	1050	1080	1110	1140	1170	1200	1230
	1260	1290	1320	1350	1380	1410	1440	1470
	1500	1530	1560	1590	1620	1650	1680	1710
	1740	1770	1800	1830	1860	1890	1920	1950
1980	2010							

ON	Response time (ms)							
								270
	300	330	360	390	420	450	480	510
	540	570	600	630	660	690	720	750
	780	810	840	870	900	930	960	990
	1020	1050	1080	1110	1140	1170	1200	1230
	1260	1290	1320	1350	1380	1410	1440	1470
	1500	1530	1560	1590	1620	1650	1680	1710
	1740	1770	1800	1830	1860	1890	1920	1950
1980	2010							

*  Default value

* Default value of OFF response time varies depending on the selected application when creating a “New” project. See Table 4-11 for the details.

* Minimum configurable response time in Master/Slave mode is,

a) 120ms for OFF and 300ms for ON when the OSSDs of the slave units are not used.

b) 60ms for OFF and 300ms for ON when the OSSDs of all the slave units are used.

3.13 Other outputs

UAM consist of 8 non-safety outputs, WARNING1, WARNING2, MUT_OUT1, MUT_OUT2, RES_REQ1, RES_REQ2, AUX_OUT1 and AUX_OUT2. WARNING1/OSSD3, WARNING2/OSSD4, RES_REQ1/MUT_OUT1/AUX_OUT1 and RES_REQ2/MUT_OUT2/AUX_OUT2 are configurable outputs that share the same terminal. When the functions are selected using UAM project designer, outputs are configured automatically.

3.13.1 Warning output 1 (WARNING 1)

This signal will switch to OFF-state when an obstacle is detected in the configured warning zone 1.

3.13.2 Warning output 2 (WARNING 2)

This signal will switch to OFF-state when an obstacle is detected in the configured warning zone 2.

3.13.3 Muting output 1 (MUT_OUT 1)

MUT_OUT1 indicates the muting/override status of the protection zone 1. When the muting function is activated, MUT_OUT1 will switch to ON-state. At the same time, number 37 is displayed on the 7-segment LED. This signal should be used to indicate that protection zone 1 is in muting state or override state.

3.13.4 Muting output 2 (MUT_OUT 2)

MUT_OUT2 indicates the muting/override status of the protection zone 2. When the muting function is activated, MUT_OUT2 will switch to ON-state. At the same time, number 38 is displayed on the 7-segment LED. This signal should be used to indicate that protection zone 2 is in muting state or override state.

When both protection zone 1 and protection zone 2 are in muting or override state, number 39 is displayed on the 7-segment LED.

3.13.5 Reset Request 1 (RES_REQ1)

This signal will switch to ON-state when the protection zone 1 of the UAM is ready to receive reset signal.

3.13.6 Reset Request 2 (RES_REQ2)

This signal will switch to ON-state when the protection zone 2 of the UAM is ready to receive reset signal.

3.13.7 Auxiliary Output 1 (AUX_OUT1)

See section 3.21 for the details.

3.13.8 Auxiliary Output 2 (AUX_OUT2)

See section 3.21 for the details.

3.14 Information indicator

LEDs and 7-segment display indicate the UAM status. These indicators are located in front of UAM. Figure 3-26 shows the information indicators of the UAM.



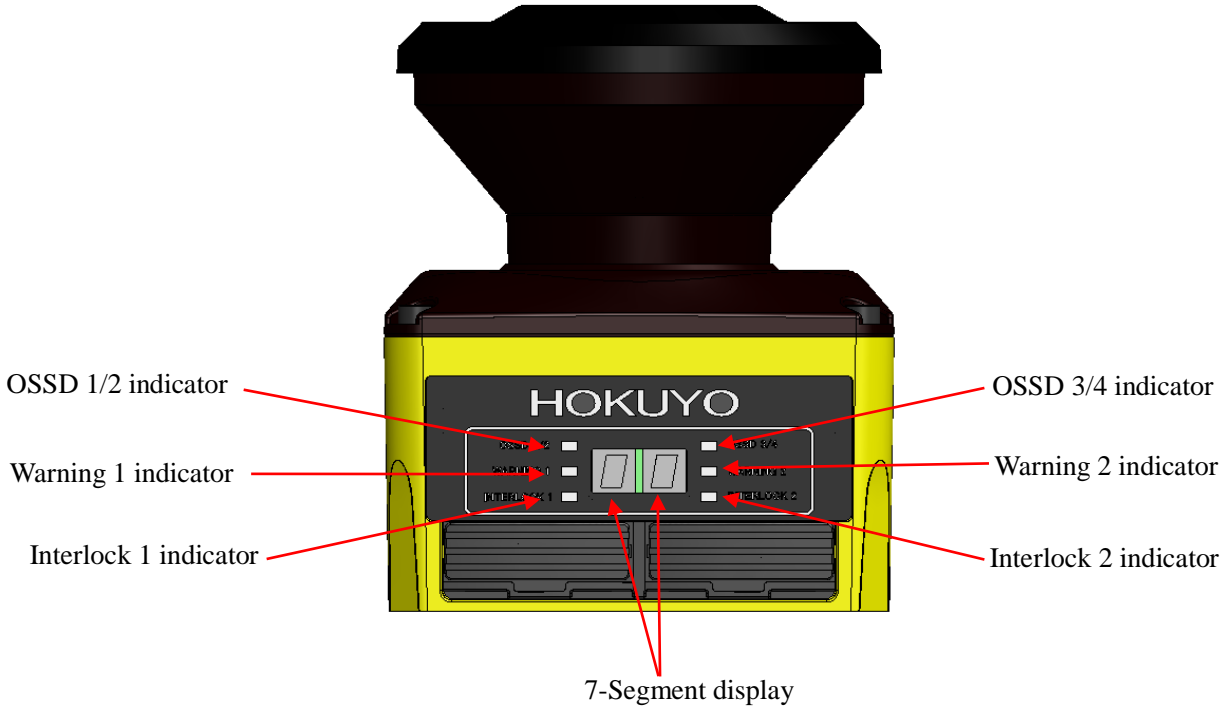

Figure 3-26 Indicator lamp

3.14.1 LED

LED indicators and their descriptions are shown in Table 3-5.

Table 3-5 Description of indicator LEDs

LED	Color	Description
OSSD 1/2	Green/Red	Green LED when OSSD 1/2 signal is in ON state, Red LED when OSSD 1/2 signal OFF state
OSSD 3/4	Green/Red	Green LED when OSSD 3/4 signal is in ON state, Red LED when OSSD 3/4 signal OFF state Green LED when OSSD 3/4 signal is not in use
WARNING 1	Orange	LED ON when Warning 1 signal is in OFF state LED OFF when Warning 1 signal is not in use
WARNING 2	Orange	LED ON when Warning 2 signal is in OFF state LED OFF when Warning 2 signal is not in use
Interlock 1	Orange	LED ON when OSSD 1/ 2 is in interlock state
Interlock 2	Orange	LED ON when OSSD 3/ 4 is in interlock state

3.14.2 7-Segment display

Table 3-6 shows the descriptions of the numbers shown 7 segment display of UAM.

Numbers can be displayed upside-down by enabling the 7-segment display function on the configuration software “UAM Project Designer”. This will help to read the numbers with ease when the device has to be inverted for the mounting. Dots on the 7-segment will illuminate when the upside-down display function is active.

Table 3-6 Description of numbers displayed on 7-segment

Display number	Details
00	Sensor is initializing
01 – 128	Selected Area - Number 1 to 32 will be static on the display - Number 33 to 128 will be scrolled from right to left on the display (only when the encoder input mode is enabled)
33	Setting mode
34	Interlock state (Protection zone 1)
35	Interlock state (Protection zone 2)
36	Interlock state (Both protection zone 1 and 2)
37	Muting or Override state (Protection zone 1)
38	Muting or Override state (Protection zone 2)
39	Muting or Override state (Both protection zone 1 and 2)
40	Laser Off mode
F2	SD card is detected with correct configuration file
F3	Configuring the sensor from the SD card information
F4	Configuring from the SD card is successful. Remove the SD card to complete the process.
F5	SD card process is complete. Sensor is going to restart.
Fb	Reset of IP address is complete. Sensor is going to restart.

Note: Display numbers other than the above are error state. For details refer to table 9-2 for details ( page 133).

3.15 Ethernet communication

Measurement data of UAM can be obtained from the Ethernet communication. Water proof Ethernet connector is located at the back of UAM. To connect sensor with PC use an Optional Ethernet cable (UAM-ENET).

UAM is compatible with SCIP2.2 communication protocol standard. Refer to UAM-05LP communication specification (C-64-00012).

3.15.1 Ethernet Setting

- **Default setting**

Factory default value is shown below.

IP address : 192.168.0.10

Default gateway : 192.168.0.1

Subnet mask : 255.255.255.0

Port number : 10940

- **Changing the IP address**

IP address can be changed by using UAM project Designer. Refer to section 7.13 and 7.9.1 for details.

- **IP address initialization**

Ethernet settings can be set to factory default by using IP initialization switch.

<Initialization steps>

- a) Prepare a thin strong pin for IP initialization process. IP initialization switch is located exactly below the SD card Slot (Refer to figure 3-27)
- b) When UAM is operating in normal state, press and hold the IP initialization switch for more than 3 seconds. After initialization process is complete 7-segment display status changes to “Fb”.
- c) Sensor restarts with 7-segment display showing the status “00”.



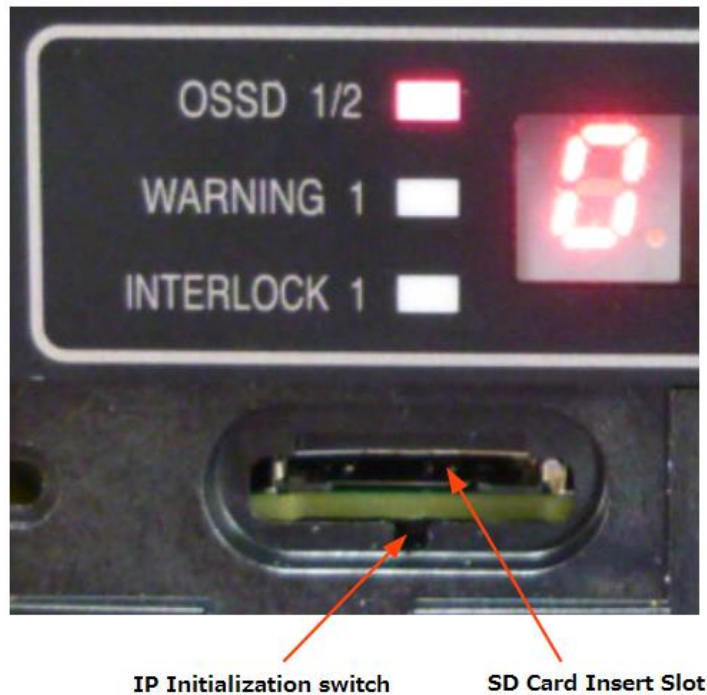

Figure 3-27 IP initialization switch

3.16 Function to configure UAM by SD card

Configuration generated by UAM Project Designer can be saved in the SD card. It is possible to transfer the setting directly from the SD Card to UAM without connecting to a PC. Recommended specification of SD card is given below.

Create a project file with set the serial number and password of the UAM and save it on the SD card using UAM Project Designer. When the SD card is inserted to the specified UAM, settings are automatically transferred. It is possible to register multiple serial number and password in the SD card to simultaneously configure multiple devices. Setting will not be transferred to the unspecified UAM or if the password verification fails.

- **Specification of SD card**

Type: Micro SD card, Micro SDHC card

Capacity: 16GB or less

3.17 Master-Slave Function

Maximum 4 units of UAM can be interconnected using RS-485 for Master/slave operation. One unit will function as a master unit communicating with up to 3 units that function as slaves via safety communication channel. Use the UAM Project Designer to configure the devices. UAM will report error if the number of master and slave units is different than the configured settings.

Area switching of the slave unit is linked with the master unit while the slave units transmit the object detection information to the master which controls the OSSD. It is also possible to use each slave unit's OSSD. Figure 3-28 shows the connection example.

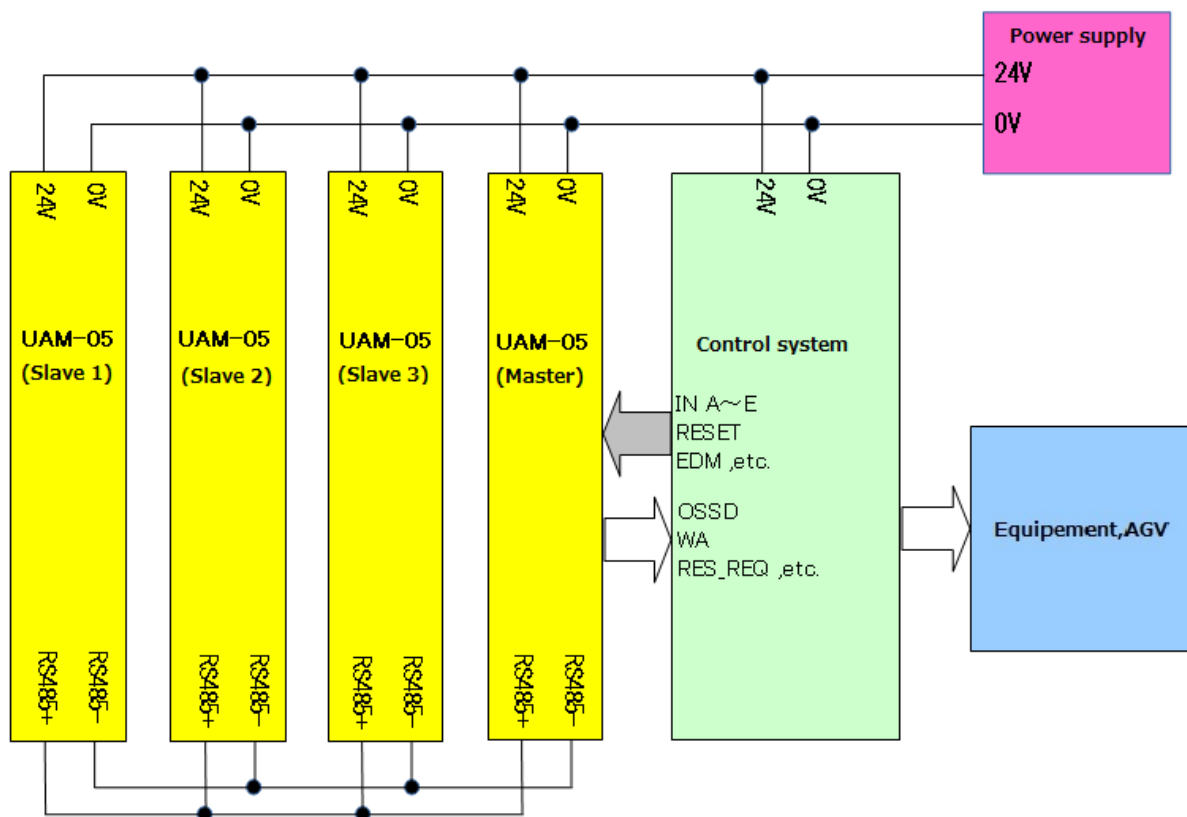

Figure 3-28 Connection example (When OSSD of slaves are not in use)



Danger

- Perform the risk assessment before using the master-slave function.
- User should comply with all the following conditions when using the master-slave function.
 1. There should be one device configured as master in the system.
 2. Number of slave units connected in the system should not exceed the slave count configured in the master unit.
 3. Configuration of slave identity number should be in the order starting from 1 without being overlapped.
 4. Verify that each device is mounted at their intended location.
 5. Verify that each device matches the intended configuration.
- Interlock function is mandatory when using the master-slave function for safety operation.
- Connecting RS485 lines to devices other than UAM, such as actuators, is not possible.
- Do not exceed the cable length between the master and each slave beyond 20m.
- Failing to comply with the above could lead to critical injury or death.

Note

- Configured active area count in master and slave units should be the same except when using the encoder input function.
- Scanning area operation mode in master and slave units should be the same.



3.18 Laser Off Mode

Laser off mode is a function to completely stop the laser emission in the measurement region in order to prevent the interference to the surrounding equipment.

When this mode is enabled, Area1 is automatically assigned for laser off function. During the operation, UAM will stop the laser emission and switch the OSSD to OFF state whenever the area is switched to Area1.

3.19 Scan Skip Function

Scan skip is a function to stop the laser emission for a specified number of scan cycles in the measurement region in order to reduce the interference to the surrounding equipment.

When this function is enabled by specifying the skip count, UAM will operate by skipping the scan for the number of cycles. During the skipping cycle the laser is switched off in the measurement region. Configurable value for skip cycle is 0 ~ 3 count. Response time of UAM for the different settings is shown in Table 3-7.

Figure 3-29 shows the operating concept when the scan skip is 0. In this configuration the scan skip function is disabled and sensor operates normally.

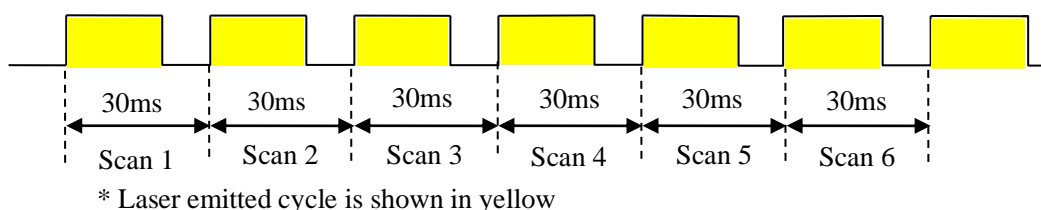

Figure 3-29 Operation of UAM when scan skip count is 0

Figure 3-30 shows the operating concept when the scan skip is set to 2. In this configuration UAM will skip the measurement for every 2 cycles in between the normal measurement cycles. Outputs states just before the skipping cycle are retained during the skipping cycle.

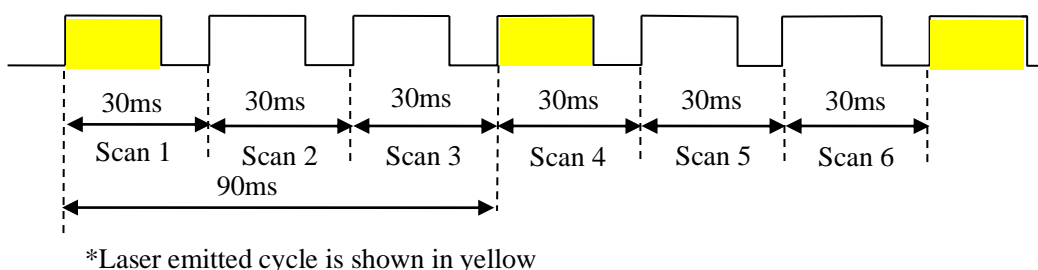

Figure 3-30 Operation of UAM when scan skip count is 2

Table 3-7 Response time for different scan skip settings

Master-Slave function disabled or when the slave OSSDs are used in master-slave mode.

Scan skip count	Off Response time (ms)							
1	90	150	210	270	330	390	450	510
	570	630	690	750	810	870	930	990
	1050	1110	1170	1230	1290	1350	1410	1470
	1530	1590	1650	1710	1770	1830	1890	1950
	2010							
2	120	210	300	390	480	570	660	750
	840	930	1020	1110	1200	1290	1380	1470
	1560	1650	1740	1830	1920	2010		
3	150	270	390	510	630	750	870	990
	1110	1230	1350	1470	1590	1710	1830	1950

Scan skip count	On Response time (ms)							
1	270	330	390	450	510	570	630	690
	750	810	870	930	990	1050	1110	1170
	1230	1290	1350	1410	1470	1530	1590	1650
	1710	1770	1830	1890	1950	2010		
2	300	390	480	570	660	750	840	930
	1020	1110	1200	1290	1380	1470	1560	1650
	1740	1830	1920	2010				
3	270	390	510	630	750	870	990	1110
	1230	1350	1470	1590	1710	1830	1950	

Master-Slave function enabled and slave OSSD outputs are not used

Scan skip count	Off Response time (ms)							
1	150	210	270	330	390	450	510	570
	630	690	750	810	870	930	990	1050
	1110	1170	1230	1290	1350	1410	1470	1530
	1590	1650	1710	1770	1830	1890	1950	2010
2	180	270	360	450	540	630	720	810
	900	990	1080	1170	1260	1350	1440	1530
	1620	1710	1800	1890	1980			
3	210	330	450	570	690	810	930	1050
	1170	1290	1410	1530	1650	1770	1890	2010

Scan skip count	On Response time (ms)							
	1	330	390	450	510	570	630	690
810		870	930	990	1050	1110	1170	1230
1290		1350	1410	1470	1530	1590	1650	1710
1770		1830	1890	1950	2010			
2	360	450	540	630	720	810	900	990
	1080	1170	1260	1350	1440	1530	1620	1710
	1800	1890	1980					
3	330	450	570	690	810	930	1050	1170
	1290	1410	1530	1650	1770	1890	2010	

3.20 Optical Window Contamination Warning Function

This is a function to warn the optical window contamination by blinking the 7-segment display number before contamination level reaches the maximum limit causing the OSSD signals to switch to OFF state. Cleaning the optical window at the blinking stage will prevent the unnecessary stop due to contamination error. No specific configuration is necessary to activate this function.

3.21 Auxiliary Output Function

Auxiliary output signals, AUX_OUT1 and AUX_OUT2 can be assigned to one of the following functions shown on the table below. However, it will be automatically assigned to Reset Request signal if the interlock function is enabled or Muting output signal if the muting function is enabled.

Further, check the box beside "Use the OSSD outputs of this device" to activate the slave's OSSDs when configuring the master-slave function.

Output	Details
Synchronous signal	UAM generates 1ms pulse is in every scan.
Error	Signal goes to ON state when UAM is in error state.
Window contamination error	Signal goes to ON state when contamination on the optical window reaches the error level.
Window contamination warning	Signal goes to ON state when contamination on the optical window reaches the warning level.

<Synchronous signal timing chart>

UAM outputs a signal synchronized with its scan at the time shown in the figure below.

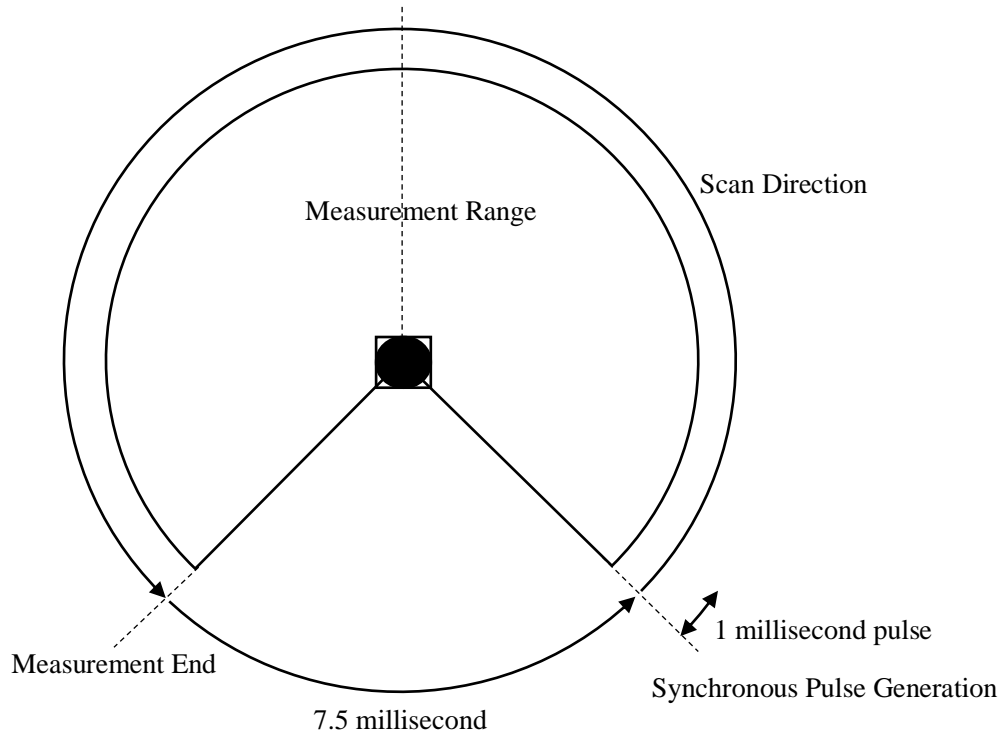

Synchronous Pulse Frequency

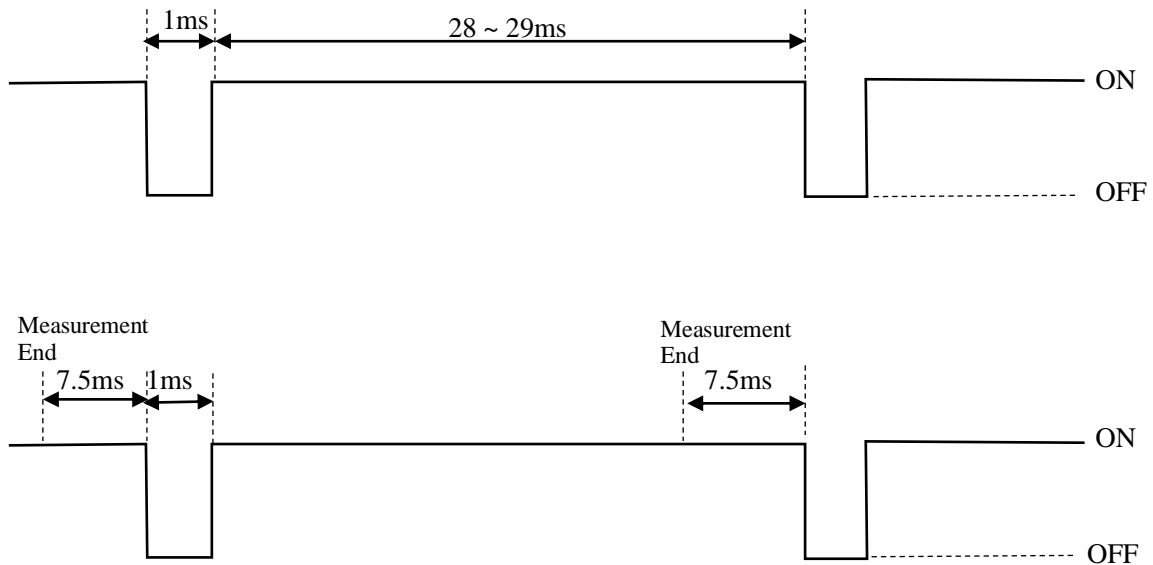

Note: Signal will be OFF when the device is in lockout state due to malfunction.



Danger

- Auxiliary output signals should not be used for the safety function. Failing to comply will lead to critical injury or death.



4. Application examples of UAM

The section describes some application examples of UAM and safety distance calculation in the respective application. When using the UAM as protective equipment, guidelines below should be taken into account.

- Hazard should be identified and risk assessment should be carried out.
- UAM should not be used for finger protection.
- Working environment should be within the specification of UAM.
- Safety distance must be determined in accordance to ISO 13855 and IEC 61496-3.



Danger

- Operating the UAM beyond its specification could lead to critical injury and death.

4.1 Access protection (Horizontal application Stationary Protection zone 1)

In this kind of application, UAM is mounted horizontally to protect the hazardous area (Figure 4-1). The protection zone is configured around the hazardous area to prevent the entry of human beings or object. Warning zone 1 and Warning zone 2 are configured surrounding the protection zone. Warning zones are used for alerting human beings or object from approaching the protection zone and preventing unnecessary stops of the protected machine. Any objects or human beings detected in the protection zone will cause the OSSD signal to switch to OFF-state from ON-state. Any objects and/or human beings detected in the warning zones will cause the warning signal to switch from ON-state to OFF-state. The safety distance for this application is shown in figure 4-2 and 4-3.

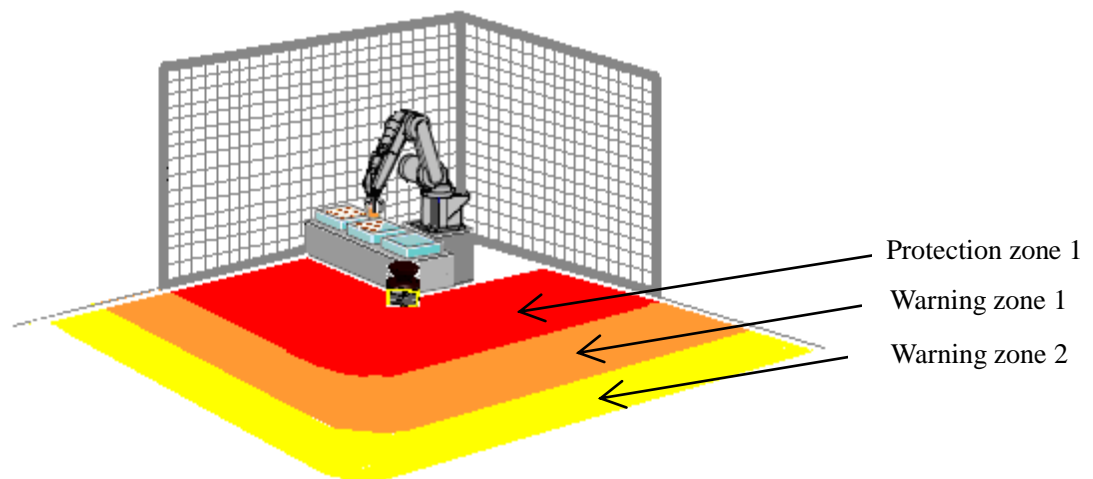

Figure 4-1 Example of access protection

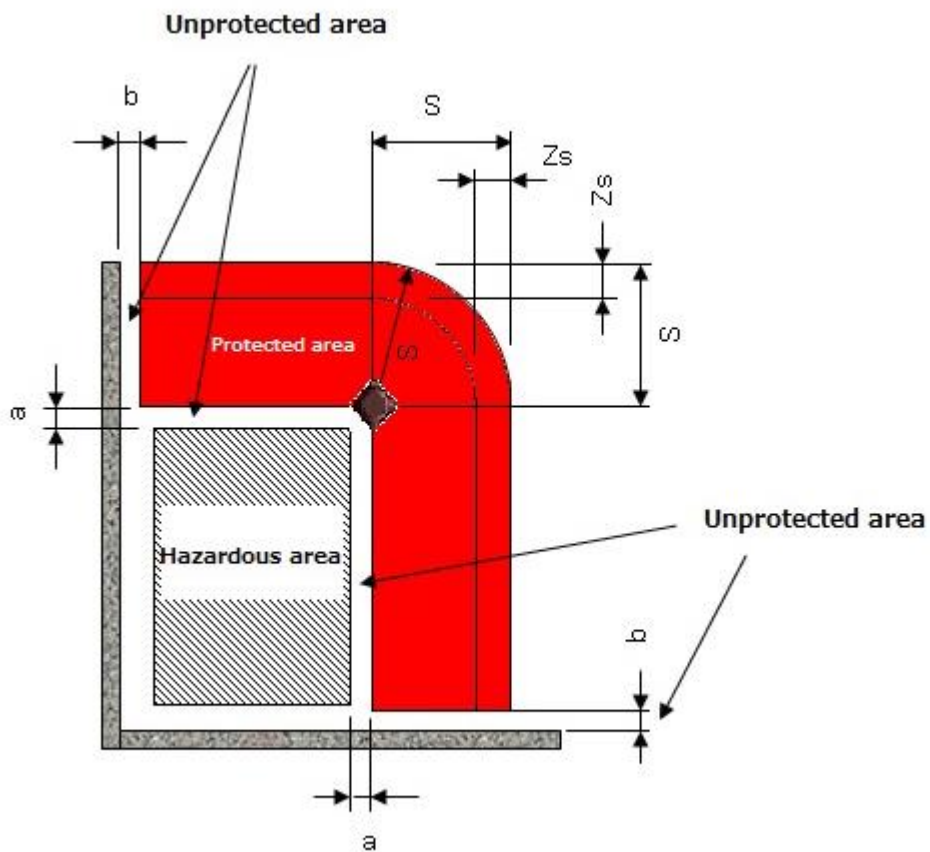

Figure 4-2 Top view of the horizontal application

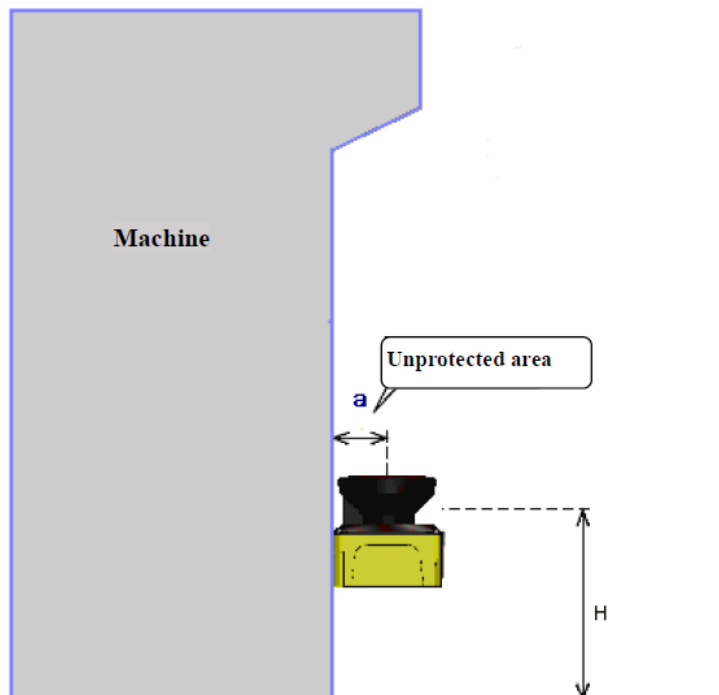

Figure 4-3 Side view of the application

For safety distance calculation:

$$S = (K \times (T_m + T_s)) + C + Z_s$$

where:

S = Safety distance (mm)

K = Approach speed 1600 (mm/s)

T_m = Maximum stopping/run-down time of the machine or system (s)

T_s = Response time of UAM (s)

C = $1200 - 0.4 \times H \geq 850$

H = the height at which the protective field is mounted (mm)

$1000 \geq H \geq 15 \times (d - 50)$

d = Minimum detectable object width (mm)

Z_s = UAM tolerance distance (mm)



Danger

- User must ensure the distance between the hazard zone edge and origin of the protection zone “a” must be less than the minimum detectable width. In application where the value of “a” is greater than the minimum detectable width, additional protective measures should be taken to prevent penetration through this unprotected area.
- UAM should not be mounted higher than 300mm to prevent the possibility of crawling beneath the detection plane.
- For applications which require the UAM to be mounted higher than 300mm, additional measures should be taken to prevent intrusion beneath the detection plane.
- If UAM is mounted in a public area, the height of the detection plane should be reduced to 200mm or to the height required by regulations of the local authority.

Note

- It is recommended to mark the floor of the protection zone.
- Distance tolerance should be taken into account when configuring the safety distance.
- Additional tolerance should be applied when UAM is used in the presence of high reflective background.
- User should ensure that boundary or protective measures used are not included inside the protected zone. They will be detected as obstacles causing the OSSD to remain in OFF-state.
- User should ensure the gap of 100mm between the protection zone and the distance of the wall “b” to prevent the detection by the sensor.

4.2 Access protection (Stationary Horizontal application with Dual Protection zone)

In this kind of application, UAM is mounted horizontally to simultaneously protect two hazardous areas (Figure 4-4). Protection zones are configured around the hazardous area to prevent the entry of human beings or object. Warning zone cannot be configuration in dual protection mode. Any objects or human beings detected in the protection zones will switch the respective OSSD signal to OFF state from ON-state.

In this configuration it is possible to protect two equipment using a single UAM.

The safety distance for this application is shown in figure 4-1.



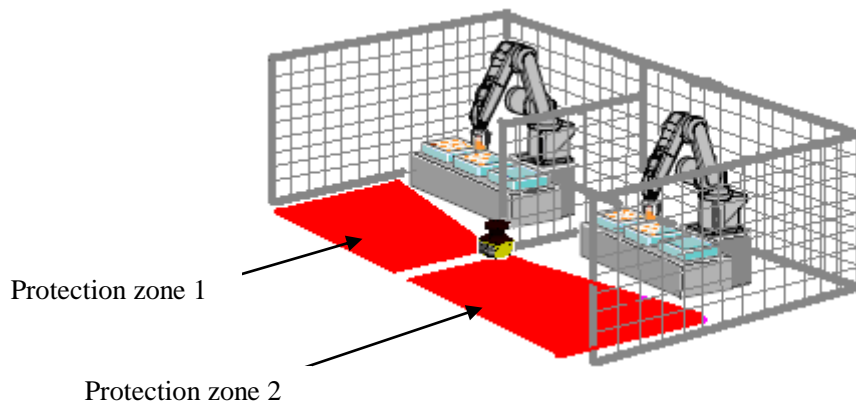

Figure 4-4 Example Horizontal application of access protection (Dual protection zone)

4.3 Access protection (Vertical application- whole body detection)

UAM can be used as a protective shield by mounting it vertically (Figure 4-5). Application shown in the figure is generally used in preventing the access to hazardous area. When an object or human enter the passage, OSSD signal will switch from ON-state to OFF-state.

In this configuration, UAM detects objects or human beings in vertical plane. It is not possible to detect an object or human being at the front or back side of the detection plane. Therefore, caution should be taken while setting the distance between the detection plane and hazardous area. Configure the shortest response time of UAM not exceeding 90ms. Always use reference monitoring function in such applications to detect the displacement of fences and UAM which may expose the hazardous area. OSSD signal will switch to OFF state when the position of reference is changed. The safety distance for this application is shown in figure 4-6 and 4-7.

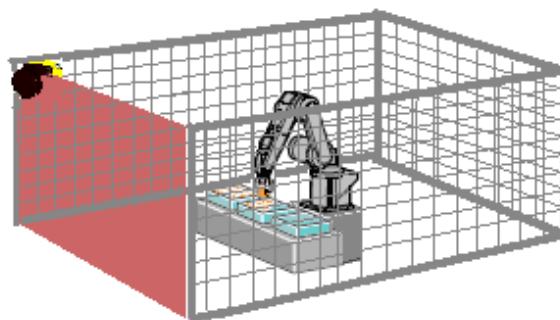

Figure 4-5 Example of access protection (Whole body detection)

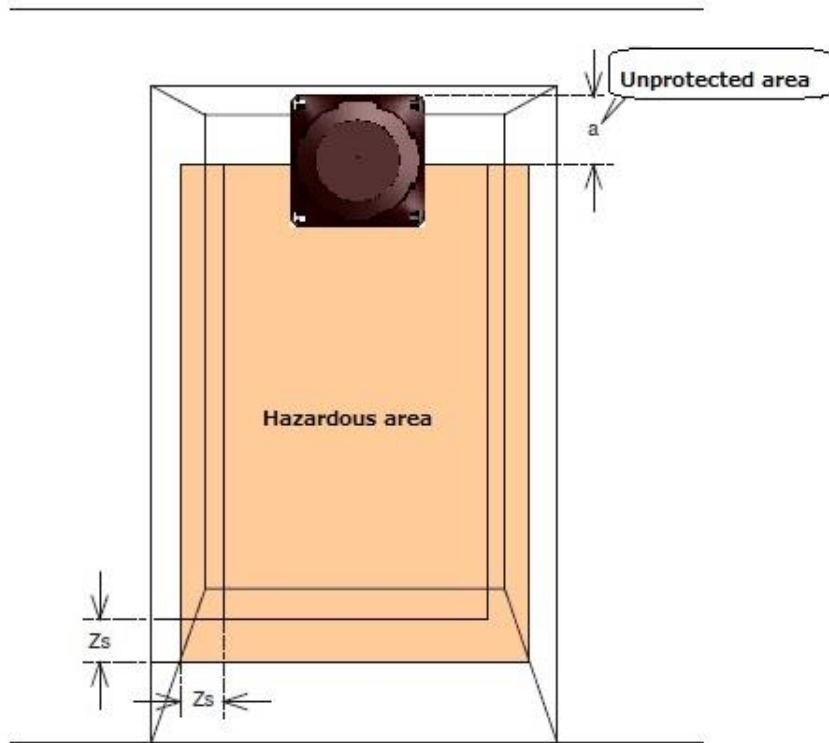

Figure 4-6 Top view of access protection (Whole body detection)

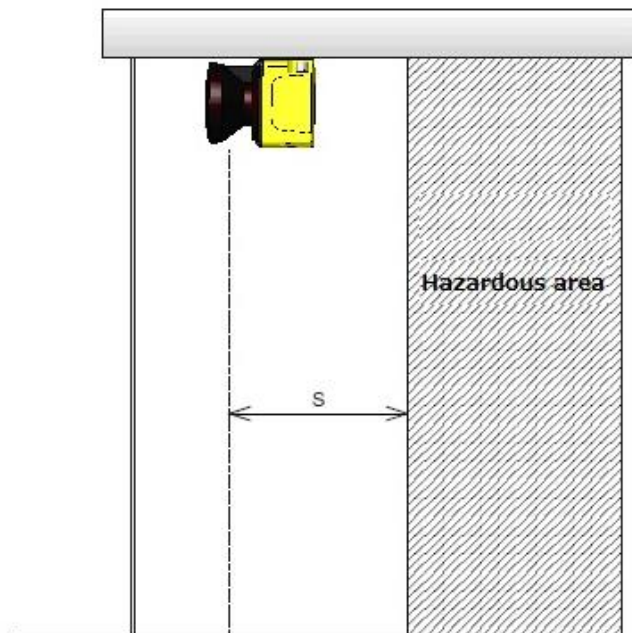

Figure 4-7 Side view of access protection (Whole body detection)

For Safety distance calculation:

$$S=(K \times (T_m+T_s))+C$$

where:

S = Safety distance (mm)

K = Approach speed 1600 (mm/s)

T_m = Maximum stopping/run-down time of the machine or system (s)

T_s = Response time of UAM (s)

C = Additional distance of 850mm by considering arm intrusion (mm)



- User should ensure that the width of unprotected zone “a” is smaller than the minimum detectable width. If the value of “a” is greater than minimum detectable width, additional protective measures should be taken to prevent the penetration through this unprotected zone.
- In the access protection application where the angle of approach exceeds $\pm 30^\circ$, “Reference monitoring” function should be used with 100mm tolerance range for the reference zone. Response time should be configured below 90ms in such application.
- Reference segments should be configured on each sides of reference boundary.
- UAM should be mounted in such a way that accessibility towards hazardous point is impossible. Use additional protective measures if necessary.
- Tolerance should be taken in account when configuring the reference segments.

4.4 Access protection (Vertical application Stationary)

Figure 4-8 shows an example to prevent the access when part of the body is approached near the hazardous area. If objects or part of body enters such area, OSSD signal switches to OFF state from ON-state. UAM detects an object or human being in vertical plane in such configuration. It is not possible to detect an object or human being at the front or back side of the detection plane. Therefore, caution should be taken while deciding the distance between approaching point and hazardous area. The width of protection zone should be sufficient to protect the hazardous area. Always use reference monitor function in such applications to detect the displacement of fences and UAM which may expose the hazardous area. OSSD signal will switch to OFF state when the position of reference is changed. The safety distance for this application is shown in figure 4-8 and 4-9. Refer to section 7 for configuring the protection zone.



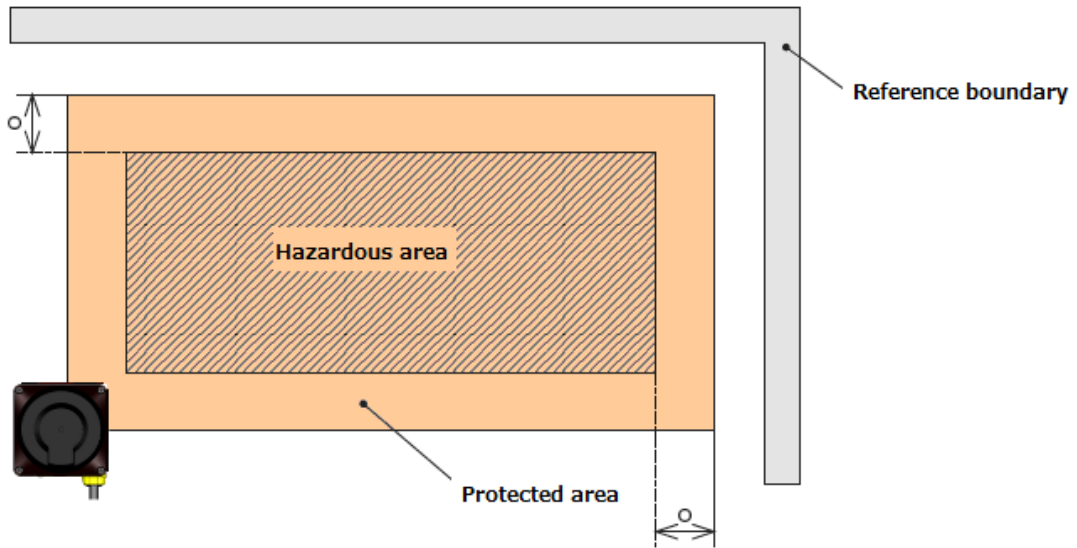

Figure 4-8 Front view of access

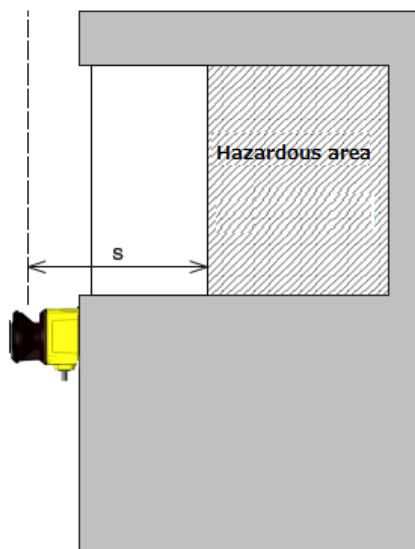

Figure 4-9 Side view of access protection (For detection of body parts)

For Safety distance calculation

$$S = (K \times (T_m + T_s)) + C$$

where:

S = Safety distance (mm)

K = Approach speed 2000mm/s

T_m = Maximum stopping/run-down time of the machine or system (s)

T_s = Response time of UAM (s)

C = Additional distance

$$= 8 \times (d - 14)$$

d = Minimum detectable object width (mm)

O = Additional width from edge of hazard source

$$\geq (2 \times Z_s) - d$$

d = Minimum detectable object width (mm)

Z_s = UAM's tolerance distance (mm)



Danger

- In the access protection application, where the angle of the approach exceeds $\pm 30^\circ$, "Reference boundary monitoring" function should be used.
- Reference segments should be configured on each sides of reference boundary.
- Tolerance of the reference segment should be less than 100mm.
- For detection of body parts, minimum detectable width should be configured as 30mm or 40mm
- UAM should be mounted in such a way that it is impossible to access the hazardous point. Use additional protective measures if necessary.

Note

- When the $S > 500\text{mm}$, value for **K** can be replace with 1600mm/s instead of 2000mm/s.
- However, minimum value of **S** will be 500mm in such cases.

4.5 Area protection (Horizontal application Mobile) Fixed area

UAM can be used for mobile applications such as AGV (Figure 4-10). It is installed on an AGV to detect objects while travelling along a fixed route. Warning signals in such application can be used for reducing the speed and stop the AGV. A maximum 32 area sets (128 area sets when encoder input function is used) can be used to match the travel route of the AGV. Confirm the time and distance required for the AGV to stop completely when configuring the protection and warning zones. The safety distance for this application is shown in figure 4-11 and 4-12.

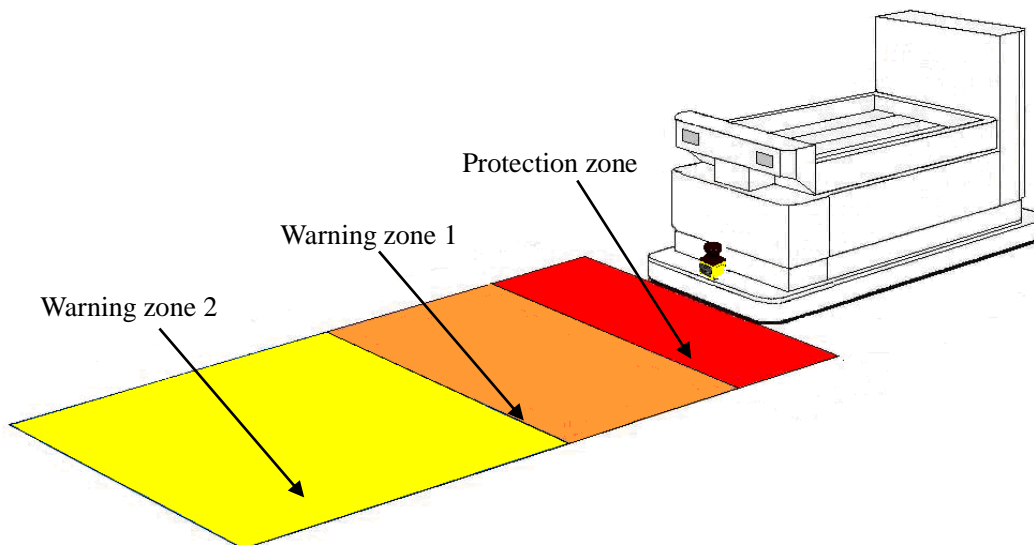

Figure 4-10 Example of area protection (Mobile)

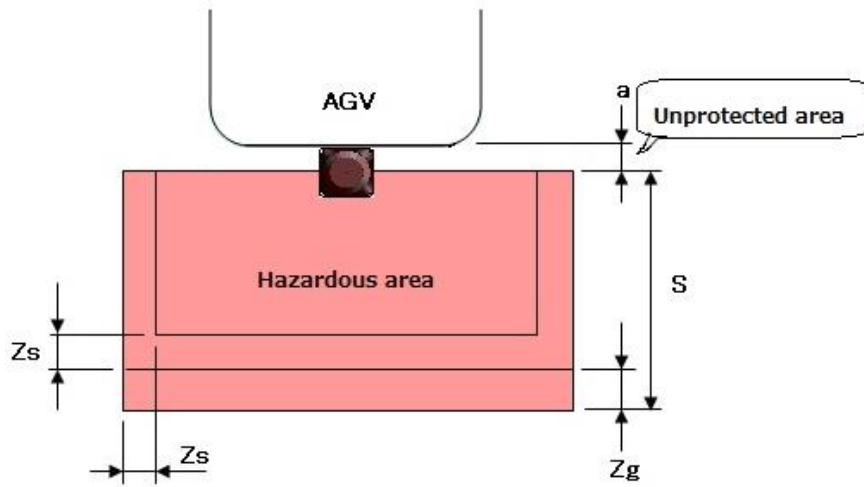

Figure 4-11 Top view of area protection (Mobile)

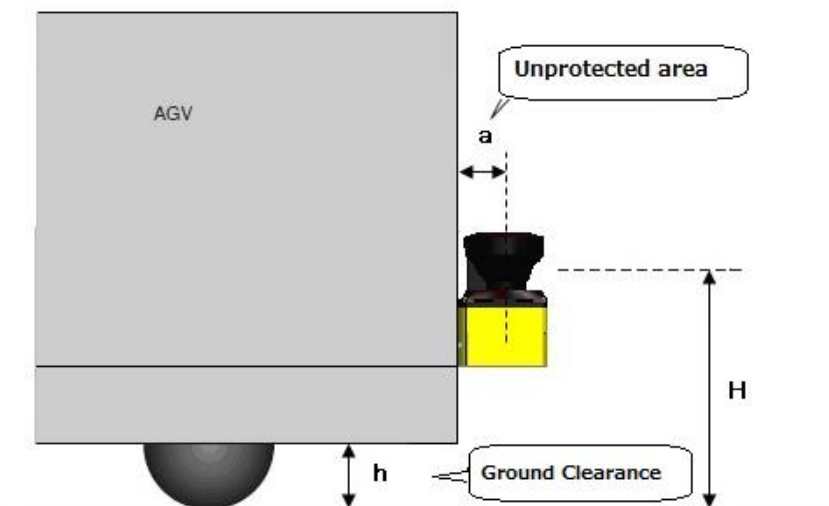

Figure 4-12 Side view of area protection (Mobile)

For Safety distance calculation:

$$S = V \times (T_m + T_s) + Z_b \times L + Z_s + Z_g$$

where:

S = Safety distance (mm)

V = Maximum approaching speed of AGV (mm/s)

T_m = Maximum stopping/run-down time of the machine or system (s)

T_s = Response time of UAM (s)

Z_b = Distance required for AGV to stop (mm)

L = Brake wear coefficient

Z_s = UAM tolerance distance (mm)

Z_g = Additional of distance with the lack of ground clearance (mm)

h = Ground clearance (mm)

When using the UAM on an AGV, user should confirm the time and distance required for the AGV to stop completely as it will move forward during the response time of UAM. It is important to note that distance required to stop is not proportional to the speed, but proportional to the square of the speed.

Further, sufficient ground clearance should be provided to prevent injuries, such as, hitting the toes. Figure 4-13 shows the relationship between ground clearance h and Z_g .

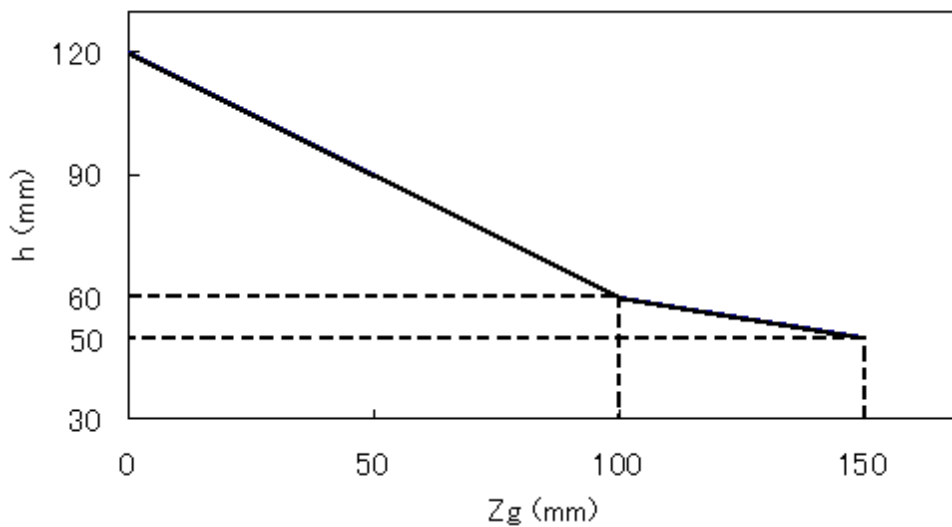

Figure 4-13 The relationship between Z_g and h



Danger

- User should ensure that the width of unprotected area “a” is smaller than the minimum detectable width. When the distance “a” is greater than minimum detectable width, additional protective measures should be taken to prevent the penetration through this unprotected area.
- UAM should not be mounted higher than 200mm to prevent the possibility of crawling beneath the detection plane.
- Detection plane should not be inclined as this could lead to the failure of UAM to detect an object with a diameter of 200mm.

Note

- User should ensure that boundary or protective measures used are not inside the configured protected zone. It will be detected as obstacles causing the OSSD to remain in OFF-state.



4.6 Area protection (Mobile, Horizontal, Single Protection, Variable Area)

For applications where AGV travels in a single direction, it is possible to switch to different areas at corners for effectively monitoring the obstacles at front (Figure 4-14).

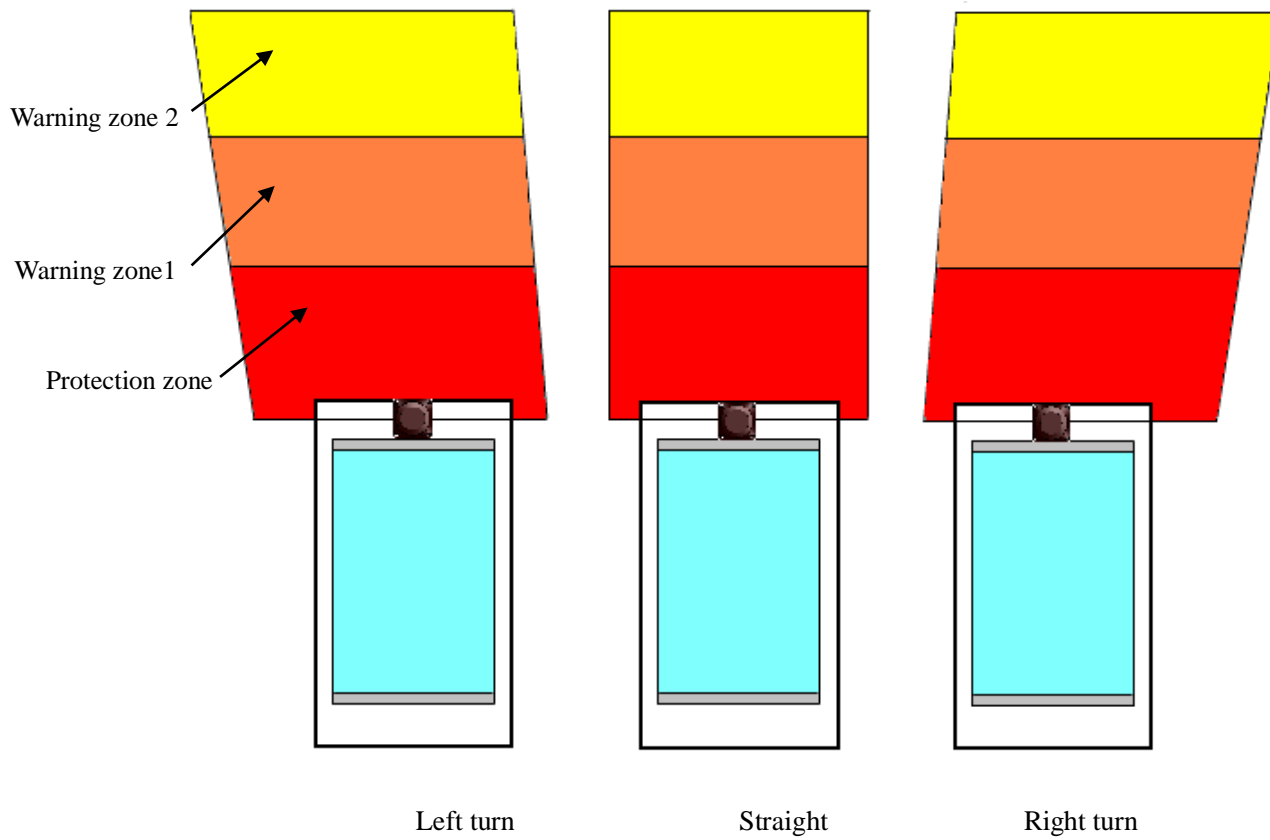

Figure 4-14 one example of AGV scanning area at curve (Top view)

4.7 Area protection (Mobile, Horizontal, Single Protection, Encoder Input)

When incremental encoder is used, area can be switched depending on the speed of AGV (Figure 4-15).

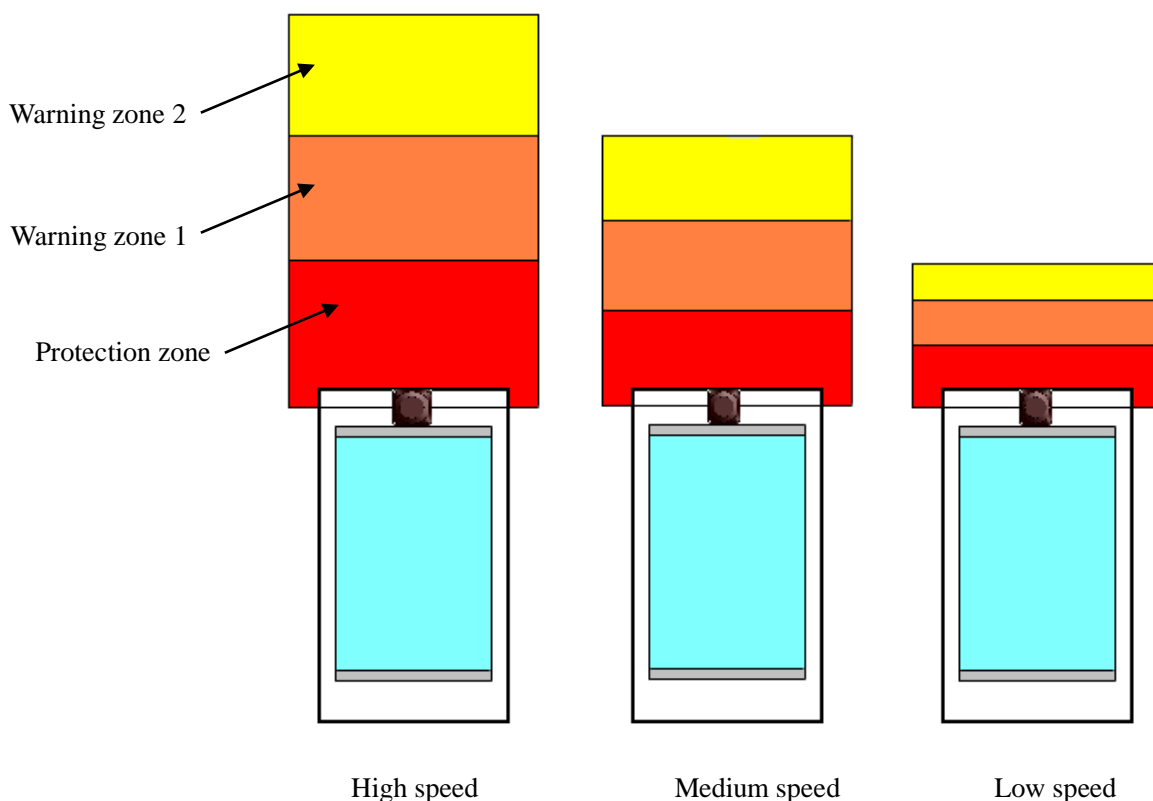

Figure 4-15 Example of AGV's scanning area depending on the speed (Top view)

4.8 Area protection (Mobile, Horizontal, 2 Units Interconnected, Variable Area)

For AGVs travelling in both directions, it is possible to use 2 interconnected units of UAM, each mounted at front and back. Safety can be improved by switching each unit to monitor the area with appropriate size and shape based on the speed and direction of travel. Further, it is also possible to use incremental encoder in such systems for area switching.

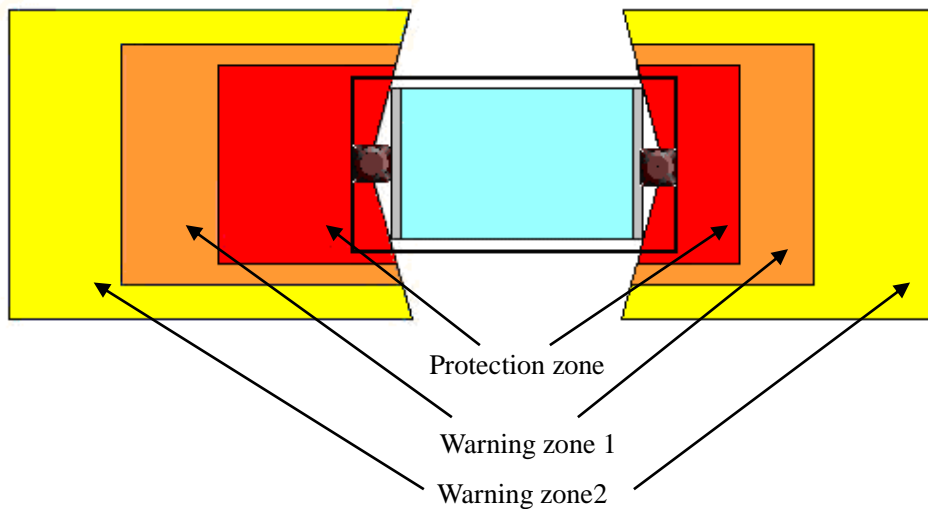

Figure 4-16 Example of AGV's scanning area which can travel in both the direction (Top view)

4.9 Area protection (Mobile, Horizontal, 4 Units Interconnected, Variable Area)

For AGVs travelling in all directions it is possible to use 4 interconnected units of UAMs mounted on each side of AGV. Safety can be improved by switching each unit to the area with appropriate size and shape based on the speed and direction of travel. Further, it is also possible to use incremental encoder in such systems for area switching.

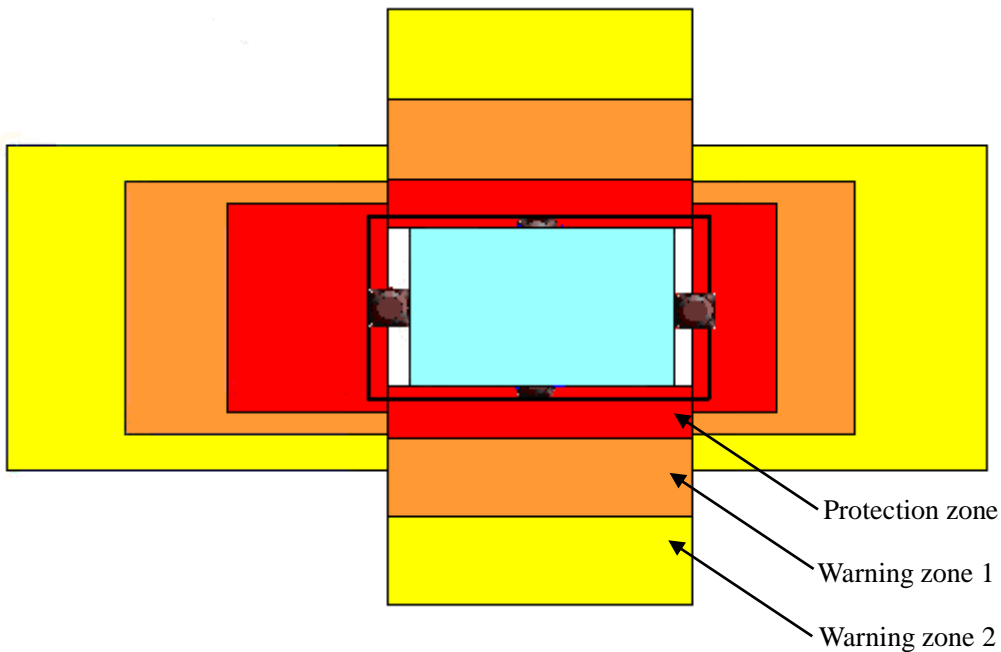

Figure 4-17 Example of AGV's scanning area which can travel in all the direction (Top view)

4.10 Area protection (Mobile, Horizontal, Autonomous Navigation)

UAM monitors both protection and warning zones and simultaneously transfers the measured data of the surrounding through the Ethernet to the main control unit of AGV. Supplied data can be used for autonomous route selection. For such systems, there is no need to install guidance means such as optical beacons or electromagnetic tapes on the floor. Refer to UAM-05LP communication protocol (C-64-00012) for the Ethernet communication protocol.

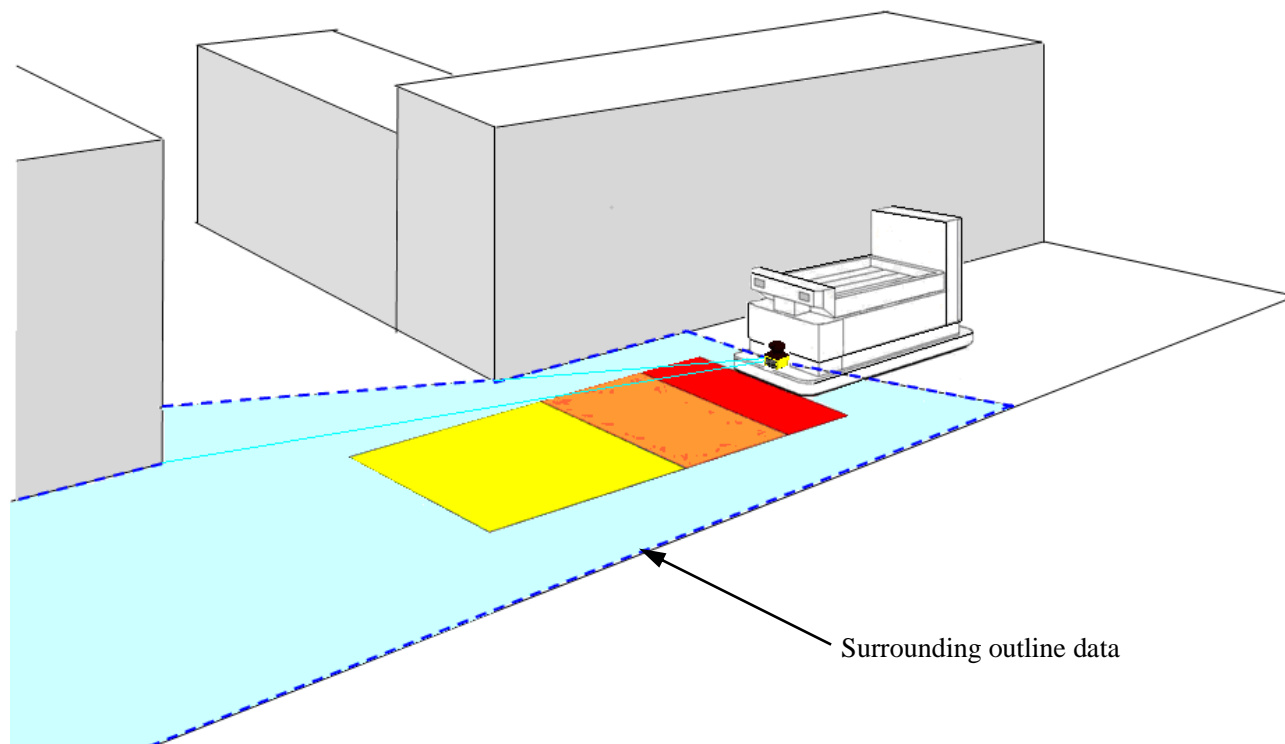

Figure 4-18 Image of automatically operated AGV

4.11 Default Values

When configuring the device, default settings will be set depending on the type of application selected on the configuration software, UAM Project Designer. Table 4-1 shows the selected values.

Area will not be configured to any default value when selecting the applications. Configure the appropriate area by calculating the safety distance or based on the risk assessment performed on the system. Perform pre-operation tests on UAM to verify the correctness of the selected parameters.

Table 4-1 Default values for selected applications

Applications	Sensing		Interlock		Reference Monitoring (Tolerance)	Off response time (Common to all areas)
	Minimum detection width	Active areas	Start/Restart Setting	Delay		
General	70mm	1	-	-	-	150ms
Access protection (Horizontal application Stationary)	70mm	1	Manual/Auto	1s	-	150ms
Access protection (Vertical application- whole body detection)	70mm	1	Manual/Auto	1s	Used (100mm)	90ms
Access protection (Vertical application Stationary)	30mm	1	Manual/Auto	1s	Used (100mm)	90ms
AGV	70mm	32	-	-	-	120ms

*Check the settings for each function and verify that they match the system requirements. Modify the values if necessary.



5. Installation

Cautions during the installation of UAM are explained in this chapter.

5.1 Light interference

UAM uses pulsed laser for object detection. Light sources in the surrounding could interfere with its operation leading to false detection. User should examine the surroundings environments before installing the UAM. Some of the light sources that could interfere with UAM are as below.

- Incandescent light
- Fluorescent light
- Stroboscopic light
- Flashing beacon
- Sunlight
- Infrared light sources

In case the light source cannot be avoided during the operation, UAM should be installed with the light source located at ± 5 degrees or more from the detection plane to prevent the interference (Figure 5.1).

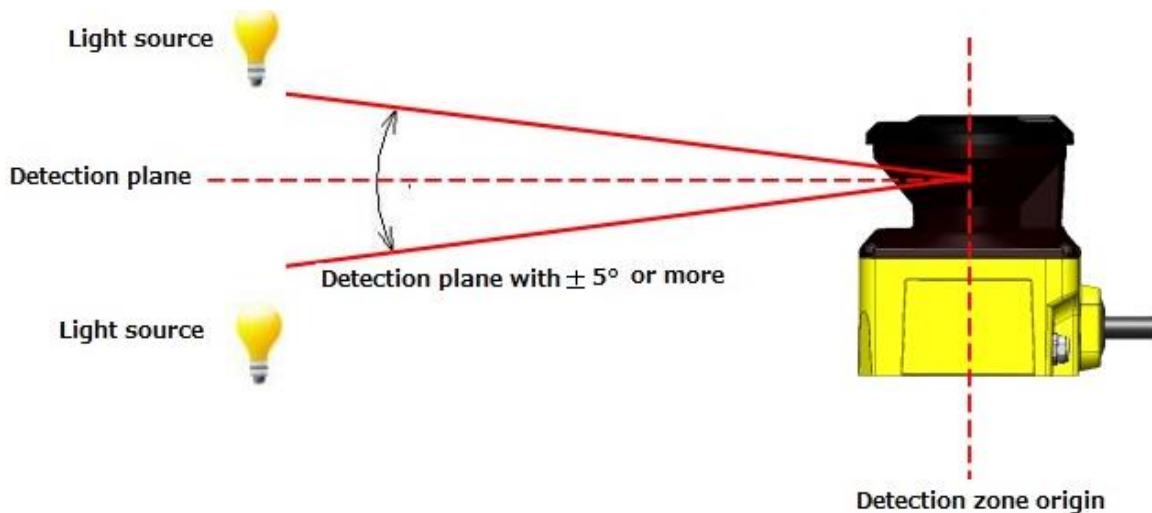

Figure 5-1 Installation to avoid light interference



Danger

- User should perform risk assessment for light interference in the working environment before the installation.
- Avoid direct light such as stroboscopic, flashing beacon, fluorescent.
- Failing to comply with the above could lead to critical injury or death.



Caution

- User should verify detection capability before actual operation.



5.2 Mutual interference

Cautions are required while using two or more units of UAM or identical products as pulsed laser signal from one another could lead to false detection. Figures below show the installation method for avoiding the mutual interference.

a) Changing the height of installation

Install at different heights to separate the mutual detection plane by 5 degrees or more.

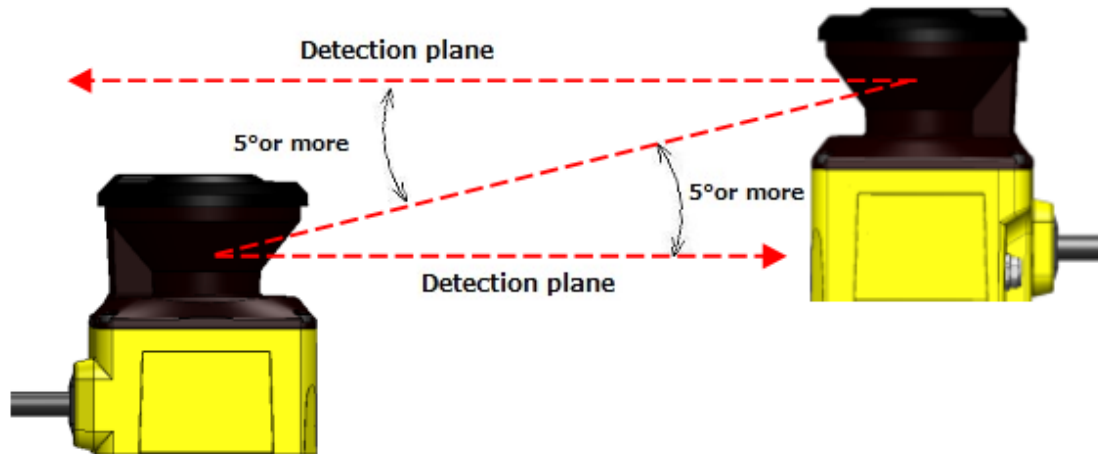

Figure 5-2 Opposite facing installation

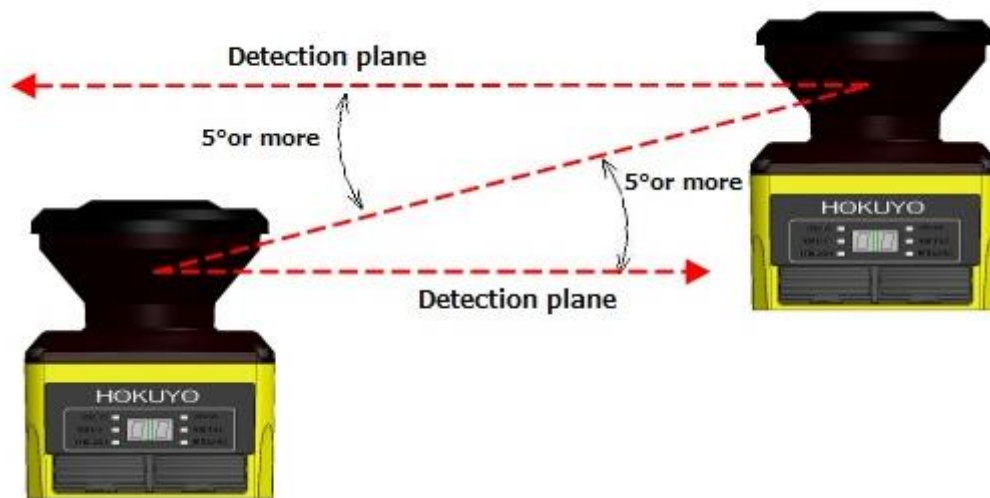

Figure 5-3 Parallel installation

b) Changing the angle of installation

Change the installation angle of UAM by 5 degrees or more from the mutual detection plane.

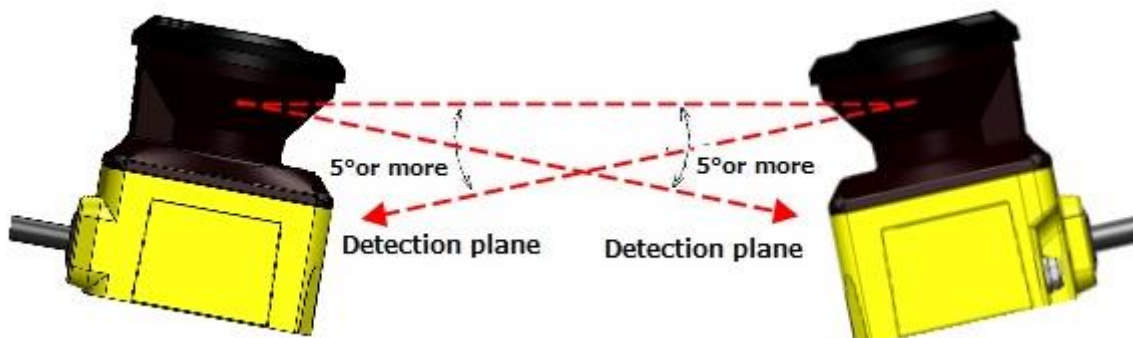

Figure 5-4 Opposite facing installation

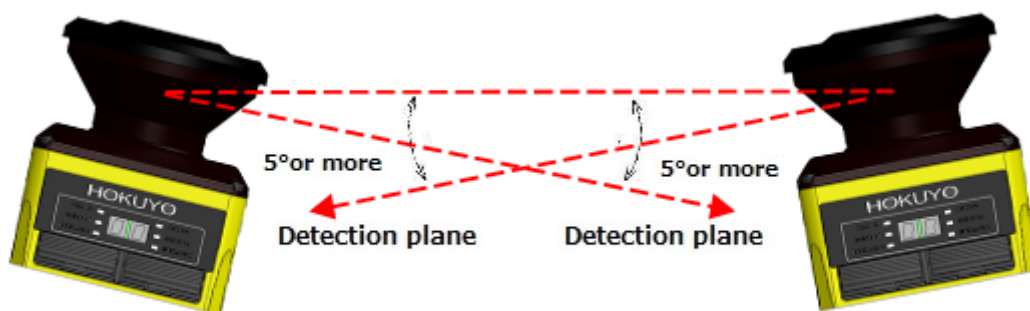

Figure 5-5 Parallel installation

C) Adding a shield between UAMs

Add a shield between UAMs such that laser beam of one unit cannot reach the other to avoid the possible mutual interference.

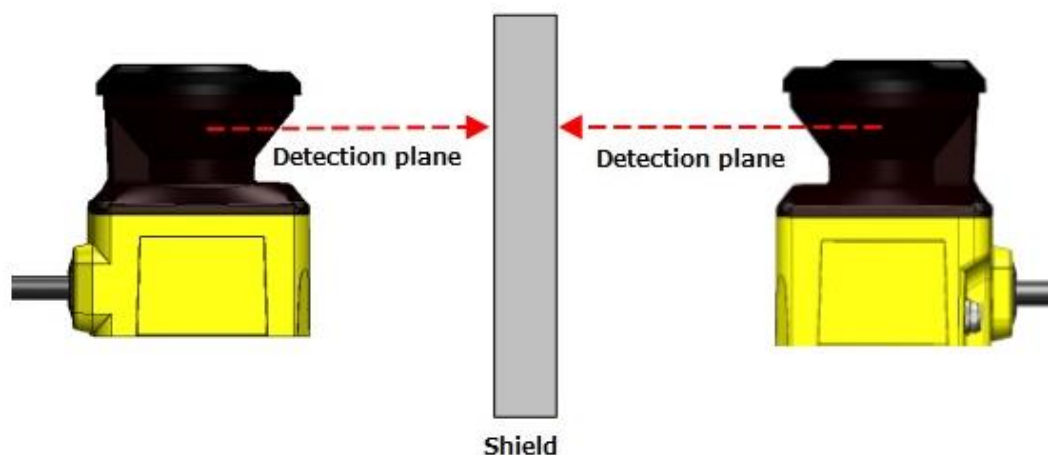

Figure 5-6 Opposite facing installation

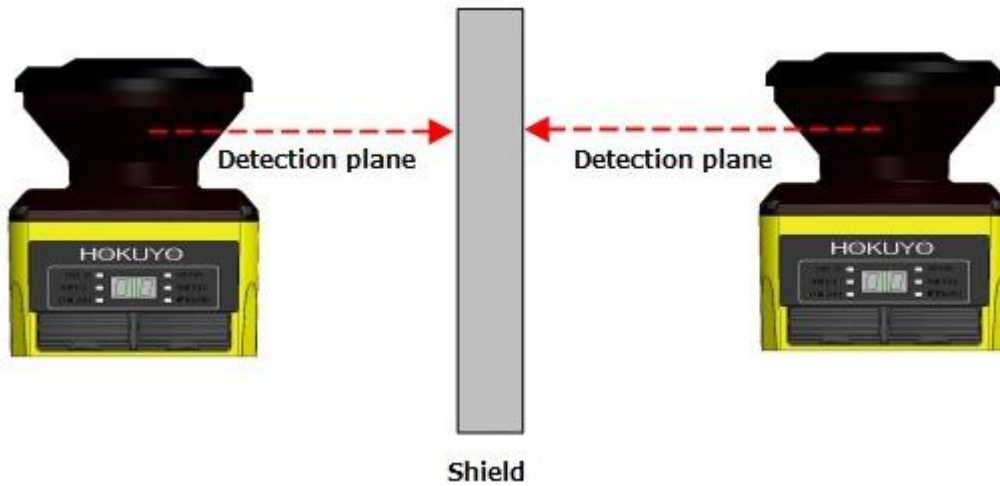
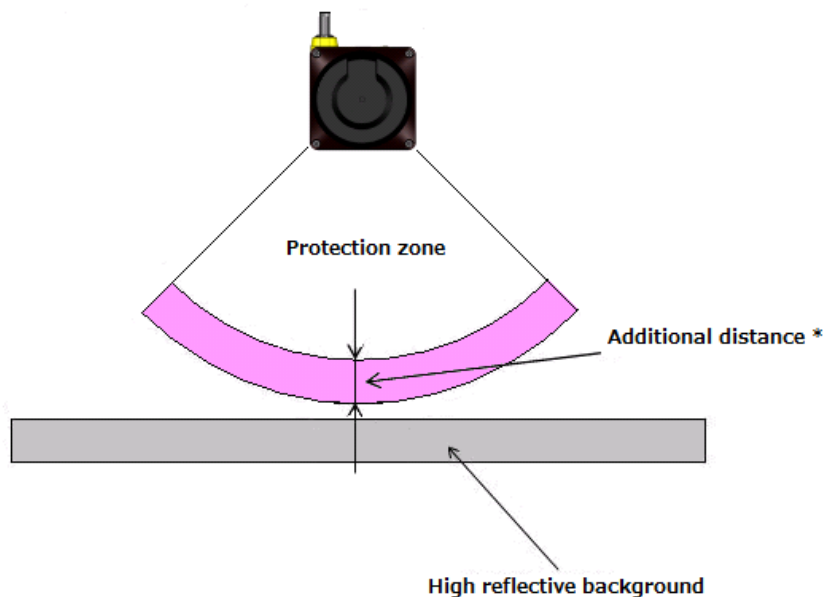

Figure 5-7 Parallel installation

Note • Shielding material should be opaque.

5.3 High reflective background

Measured value will be longer than the actual distance of the object due to high reflective background leading to wrong OSSD output. When high reflective background cannot be avoided in the working environment, additional distance of 200mm is necessary while configuring the protection and warning zones (Figure 5-8). Refer to UAM's specification for the required distance tolerance.



* Additional distance : Required additional distance when operating UAM under high reflective background

Figure 5-8 Additional distance in high reflective background



Danger

- Measured value will be longer than actual distance of the object if the background is highly reflective. Additional distance should be included when configuring the protection zone.
- High reflective background (Ex.: Mirror, corner cube reflector, reflective safety jacket, road reflector) should be avoided. Reflectance caused by these materials could lead to false detection in the protection zone.
- Verify the configured areas before actual operation.
- Failing to comply with the above could lead to critical injury or death.

5.4 Limited detection capability zone

The limited detection capability zone is defined as a region between the optical window and start of the detection zone. The limited detection capability zone of the UAM is 90mm from the origin of UAM (Figure 5-9). Presence of object with low reflectance may not be detected in this zone.



Figure 5-9 Limited detection capability zone



Danger

- User should perform risk assessment for possibility of object penetration into the limited detection capability zone.



6. Wiring

This chapter describes safety precaution when wiring the UAM.

6.1 Precautions

- During electric wiring make sure that all devices are disconnected from power supply. Switch off all the power supply during wiring. Confirm that power supply is OFF.
- Do not exceed cable length stated in the specification of UAM.

6.2 Power supply

Make sure that power supply is within the range of DC 24V \pm 10%. For battery operation, power supply should be within the range of DC 24V -30% / +20%. UAM could be damaged if rated output voltage exceeds this range.



Danger

- For safety, switch OFF the power supply during electrical wiring.
- Do not use cables longer than those mentioned in the specification of UAM.

6.3 Wire color and function

Table 6-1 shows the color of each lead wire, signal name and function. It is recommended to use the shielded cable for wiring.

Table 6-1 Wire color and function

Color	Signal	Function	Description	AWG
Brown	+ 24 DC	Power	Power Supply: DC 24V	22
Blue	0V DC	Power	Power Supply: DC 0V	22
Red	OSSD1	Output	Protection zone output 1	26
Yellow	OSSD2	Output	Protection zone output 2	26
Red/Black	WARNING 1/ OSSD3	Output	Warning zone output 1/Protection zone output 3	28
Yellow/Black	WARNING 2/ OSSD4	Output	Warning zone output 2/Protection zone output 4	28
Purple	IN_A	Input	Area switching Input A	28
Gray	IN_B/ MUTING 3	Input	Area switching Input B / Muting input 3	28
White	IN_C/OVERRIDE1/ ENC1_A	Input	Area switching Input C/Override input 1/ Encoder input 1_A	28
Pink	IN_D/ MUTING 1/ENC1_B	Input	Area switching Input D / Muting input 1/ Encoder input 1_B	28
Green	IN_E/EDM1	Input	Area switching Input E /External device monitoring 1	28
Purple/Black	IN_A	Input	Area switching Input A invert	28
Gray/Black	IN_B/ MUTING4	Input	Area switching Input B invert / Muting input 4	28
White/Black	IN_C/OVERRIDE2/ENC2_A	Input	Area switching Input C invert / Override input 2/Encoder input 2 A	28
Pink/Black	IN_D/ MUTING2/ENC2_B	Input	Area switching Input D invert / Muting input	28



			2 / Encoder input 2 B	
Green/Black	IN_E/EDM2	Input	Area switching Input E invert / External device monitoring 2	28
Yellow/Green	RESET 1	Input	Reset input 1	28
Yellow/Blue	RESET 2	Input	Reset input 2	28
Orange	RES_REQ1/MUT_OUT1/AUX_OUT1	Output	RES_REQ1: ON when resuming the OSSD1/2 signal from interlock state using external inputs. MUT_OUT1: ON when OSSD1/2 signals are performing muting operation. AUX_OUT1: Synchronous signal/Error/Window contamination error/Window contamination warning (see section 3.21 for details)	28
Orange/Black	RES_REQ2/MUT_OUT2/AUX_OUT2	Output	RES_REQ2: ON when resuming the OSSD3/4 signal from interlock state using external inputs. MUT_OUT2: ON when OSSD3/4 signals are performing muting operation. AUX_OUT2: Synchronous signal/Error/Window contamination error/Window contamination warning (see section 3.21 for details)	28
White/Blue (TP)	RS485+	Communication	Communication protocol RS485	28
White/Red (TP)	RS485-	Communication	Communication protocol RS485	28
Shield wire	FG	—	Frame ground	—



6.4 Wiring example

a) Standard (With maximum 32 sets of area)

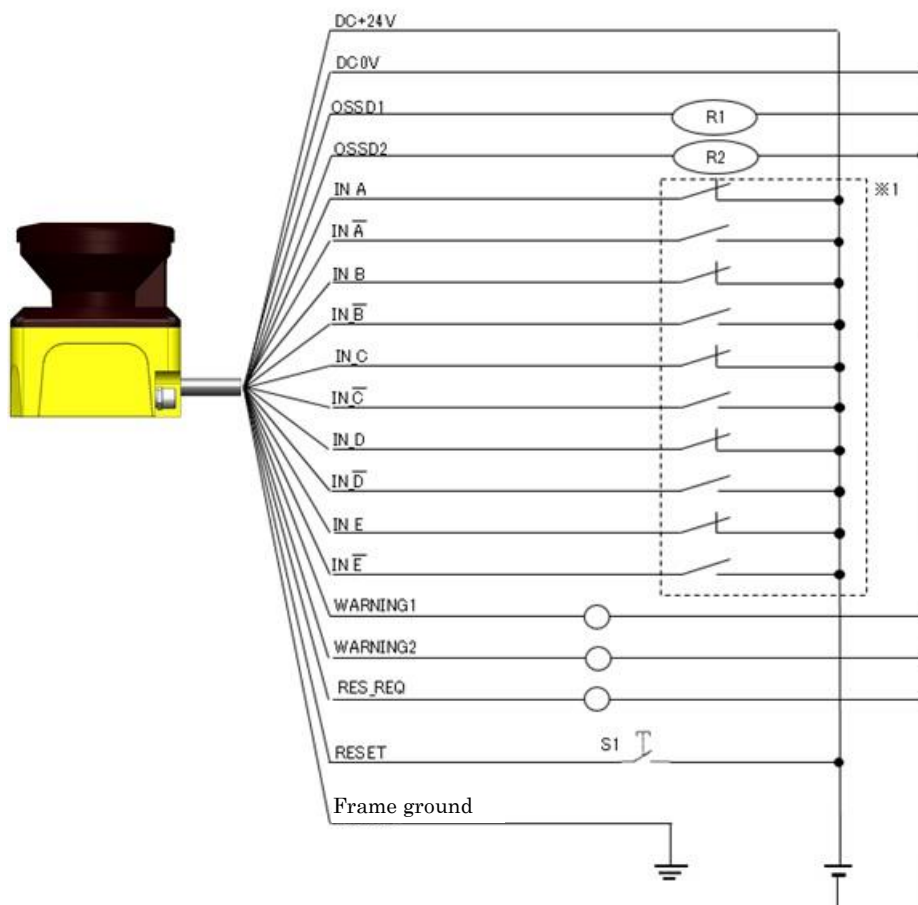

Figure 6-1 Wiring Example 1

R1 and R2: External equipment (Safety relay, Electromagnetic contactor)

S1: Interlock reset switch

*1: Refer to section 3.5 for the detail on area switching.

b) During EDM, muting and override function

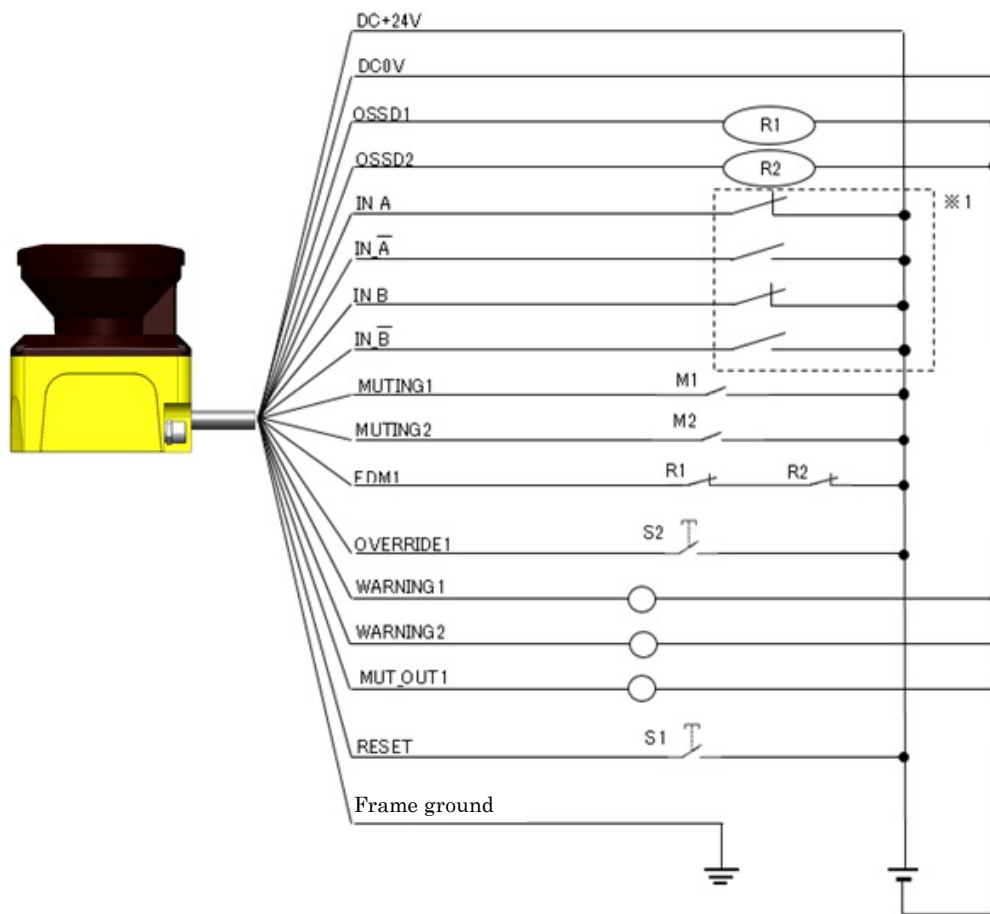

Figure 6-2 Wiring Example 2

R1 and R2: External equipment (Safety relay, Electromagnetic contactor)

S1 : Interlock reset switch

S2 : Override switch

M1 and M2 : Muting switch 1 and 2

*1: Refer to section 3.5 for the detail on area switching.

c) During area switching during encoder input

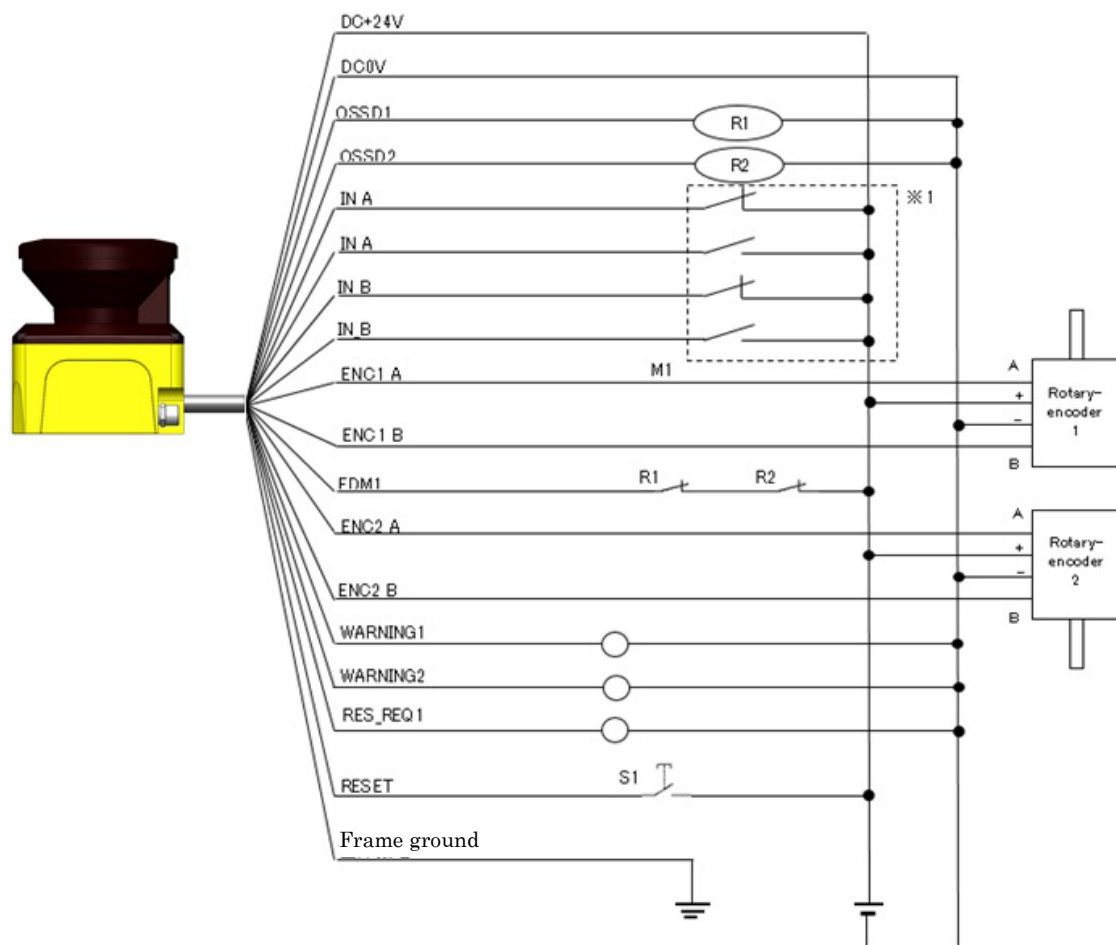

Figure 6-3 Wiring Example 3

R1 and R2: External equipment (Safety relay, Electromagnetic contactor)

S1 : Interlock reset switch

*1: Refer to section 3.5 for the detail on area switching and section 3.6.4 for encoder input.

d) During Master slave function when not using OSSD of slave

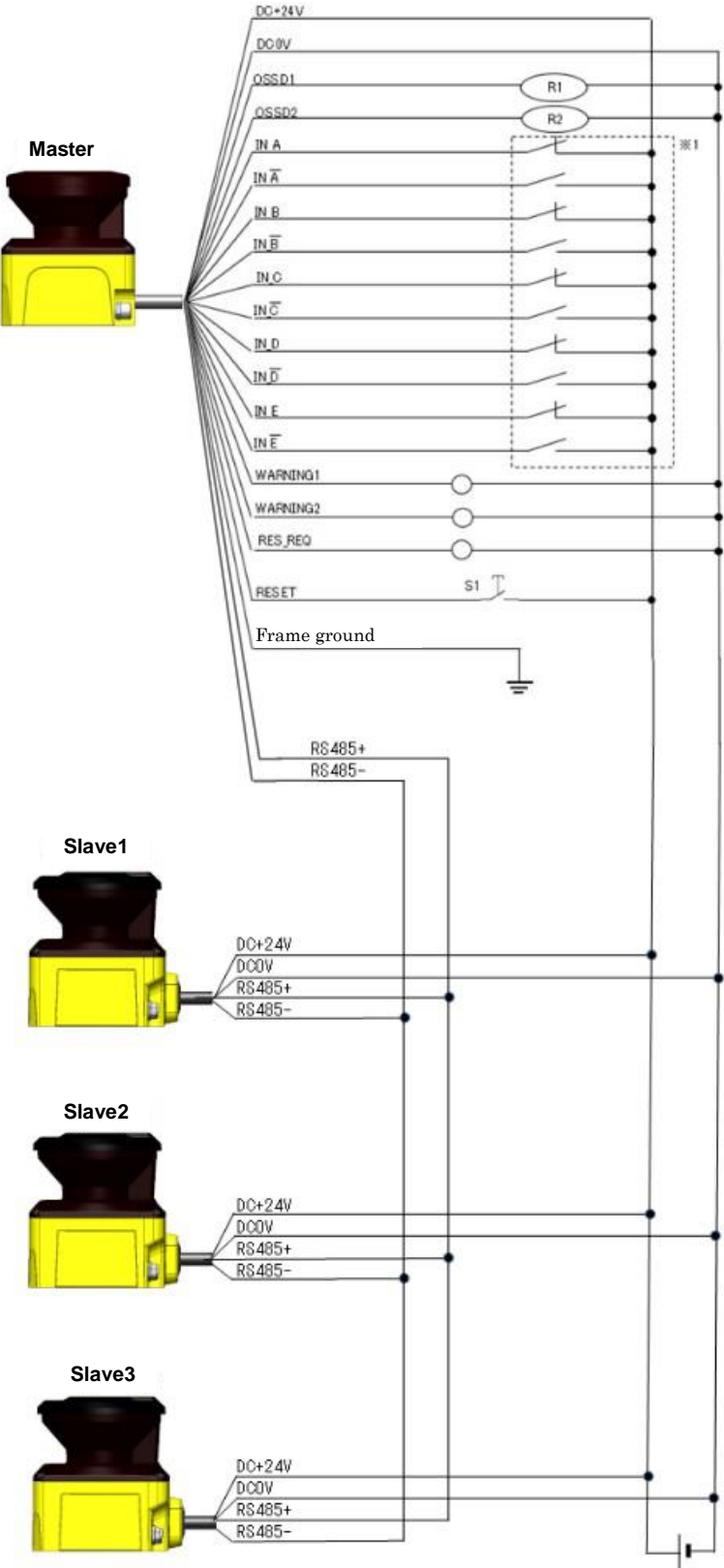

R1 and R2: External equipment
 (Safety relay, Electromagnetic contactor)
 S1 : Interlock reset switch
 *1: Refer to section 3.5 for the detail
 on area switching.

Figure 6-4 Wiring Example 4

e) During Master slave function when using OSSD of slave

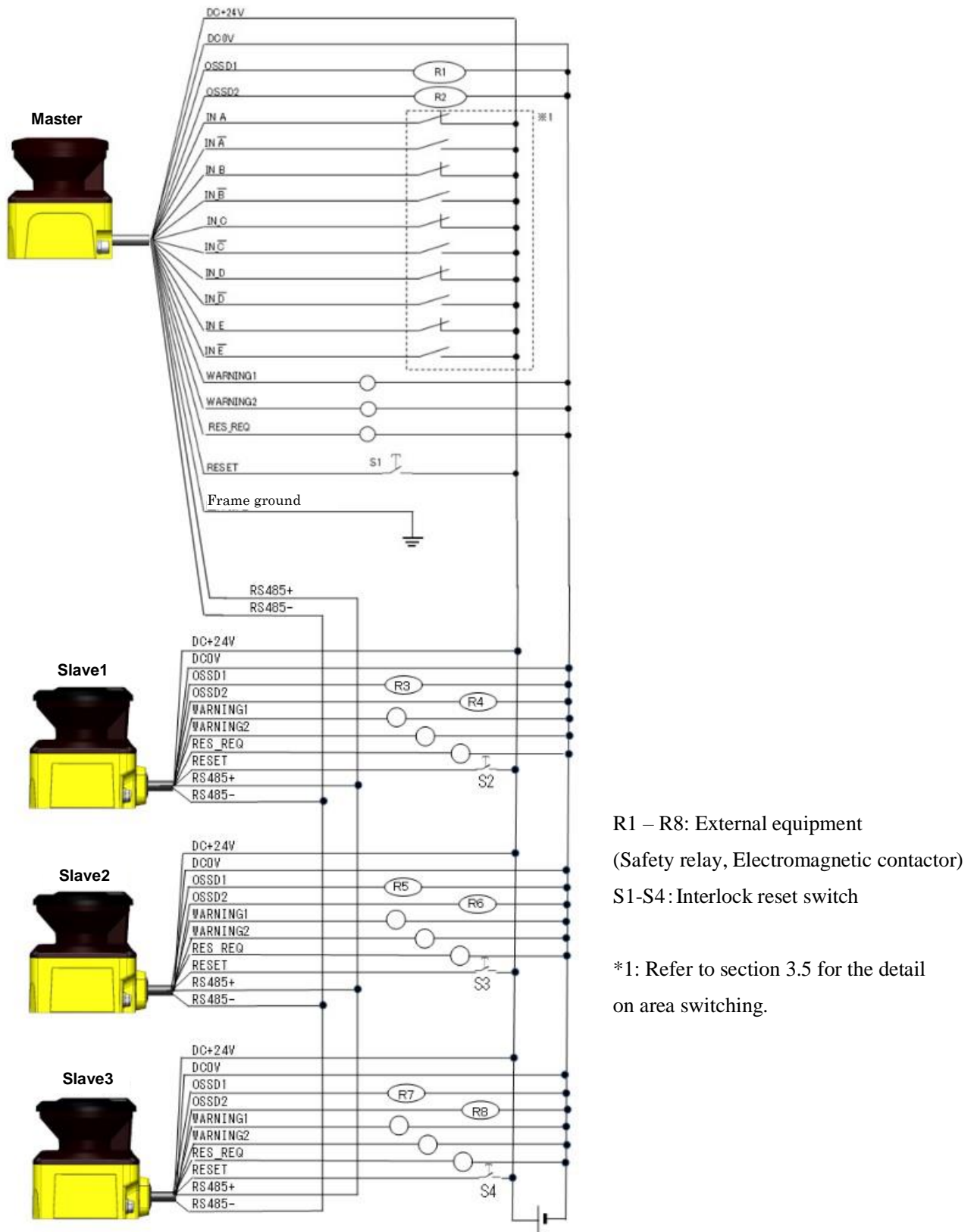

Figure 6-5 Wiring Example 5

6.5 Input/ Output circuit

6.5.1 OSSD/ Warning Output circuit

OSSD/Warning output is output source type

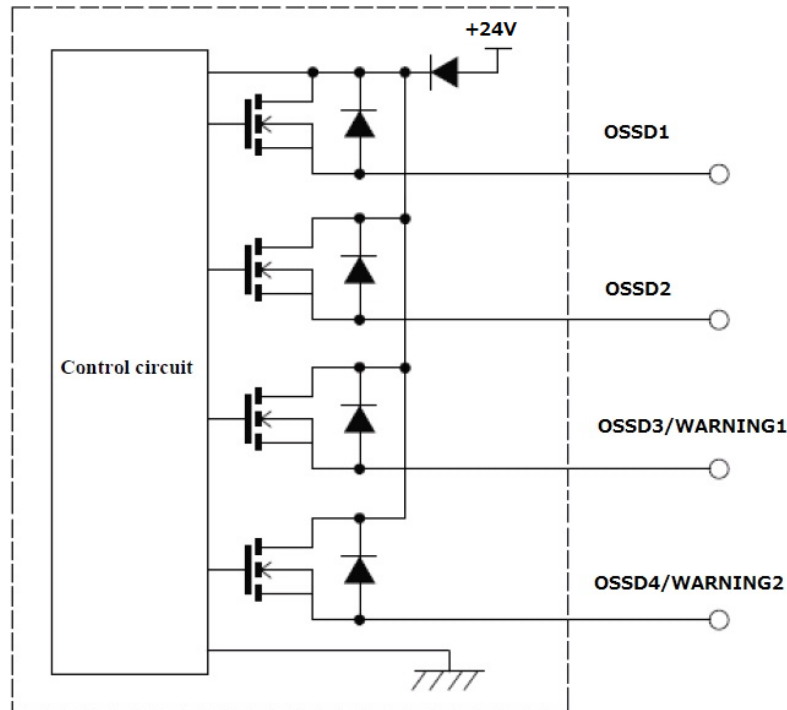

Figure 6-6 OSSD/WARNING Output circuit

6.5.2 Other output circuits

RES_REQ1, RES_REQ2, MUT_OUT1, MUT_OUT2, AUX_OUT1, AUX_OUT2 outputs are PNP type.

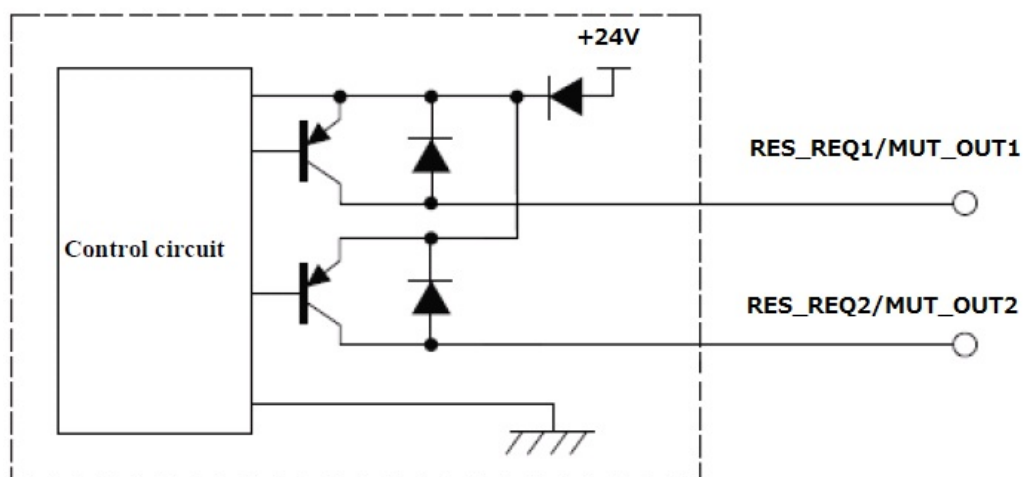

Figure 6-7 Output circuit

6.5.3 Input circuit

Figure 6-8 shows input circuit for Area input, EDM1, EDM2, RESET1, RESET2, MUTING 1, MUTING 2, MUTING 3, MUTING 4, OVERRIDE 1, and OVERRIDE 2 signals.

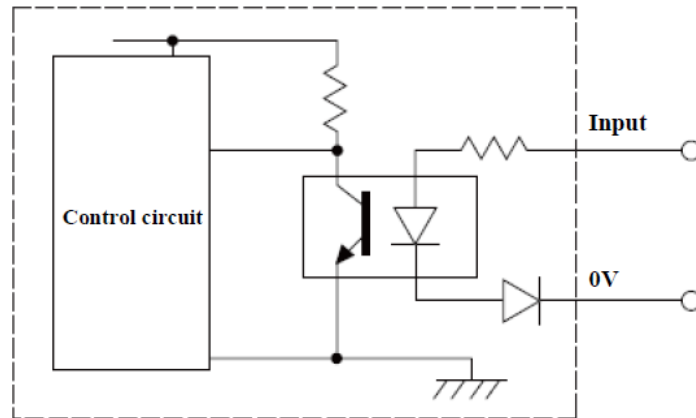

Figure 6-8 Input circuit

7. Function configuration of UAM

7.1 About UAM Project Designer application

UAM project designer is application software for UAM that is developed for the following functions.

- Protection and warning zone configuration
- Function configuration
- Displaying the measurement data
- Record and playback of measurement data
- Project data management (saving and opening the project data).

Note ● Figures, illustrations, displays and indications in this manual may differ depending on user's system or environment settings.

7.2 System requirements

Table 7-1 Minimum system required for UAM Project Designer

Item	Explanation	
Interface	USB 1.1/2.0	
PC	CPU	Pentium® IV processor of 800MHz or above
	RAM	256MB or more
	Hard disk	100MB minimum free space
	Media Drive	CD-ROM driver
Compatible OS	Microsoft® Windows® XP	32bit (SP3 or above)
	Microsoft® Windows® 7	32/64bit
	Microsoft® Windows® 8	32/64bit
	Microsoft® Windows® 8.1	32/64bit
	Microsoft® Windows® 10	32/64bit
Display	High color (16bit color) or above , 800×600 dot or above	

Operation cannot be guaranteed for the following system environment.

- OS other than mentioned above.
- NEC PC98 series and its compatible device.
- Self-assembled PC
- Multi boot environment
- Multi monitor environment
- Upgraded OS from the standard OS



Note

- Even if the system requirements are fulfilled, operation is not guaranteed in all PCs.
- Read the UAM user's manual before configuration. User's manual can be opened from the help menu of UAM Project Designer.
- Cover the USB connector and SD card slot with protective cap when UAM is operating. Make sure that mist or dust does not enter the device.
- Do not use the USB cable of mobile chargers. It is recommended to use a standard USB cable and avoid the winding type.

7.3 Installation of UAM Project Designer

- a) Insert the CD into the CD-ROM drive.
- b) Click "UAM Project Designer_*.*)_installer.exe.
- c) Follow the instructions to complete the installation.

Note

- Log in as "Administrator" to authorize the installation of the UAM Project Designer.
- Installation cannot proceed if PC is not running in "Administrator" mode.
- UAM project designer is installed at "C:\Program Files Hokuyo\UAM Project Designer" by default. To install in different folder, change this location during the installation process.

7.3.1 Uninstallation UAM Project Designer

Process to uninstall the UAM Project Designer is as shown below.

- a) Select all programs from the start menu.
- b) Select "Uninstall UAM Project Designer" in the "UAM Project Designer" folder.
- c) When "Are you sure you want to completely remove UAM Project Designer and all of its related components?" message appears, click [Yes] to uninstall the program from the PC.
- d) Click [OK] when uninstalling process is complete. Restarting the PC is recommended.

Following is the alternative method to uninstall the application,

- a) Select the "Control Panel" in the start menu.
- b) Click the "Uninstall Programs".
- c) Select "UAM Project Designer" and click [Delete].
- d) When "Ready to uninstall UAM Project Designer" appears, click [Yes] to uninstall the program from the PC.
- e) Click [OK] when uninstalling process is complete. Restarting the PC is recommended.



7.4 Device driver installation

7.4.1 Installing the driver in Windows 8

In Windows 8, permission setup is required before installing the USB driver.

Caution:

This step is not required for Windows 7. Proceed to section 7.4.2 for such OS.

This step is not required for Windows XP. Proceed to section 7.4.3 for such OS.

This step is not required for Windows 10. Proceed to step 7.4.4 for such OS.

- a) Display the side menu by moving the mouse cursor to the top right or bottom right corner or click  Start Menu + “C key” and click on the “Setting”. When using a tablet, swipe from the right edge of the screen towards the center.



Figure 7-1 Windows 8 Start screen

- b) On the setting screen click the “Change PC setting” located at the bottom.

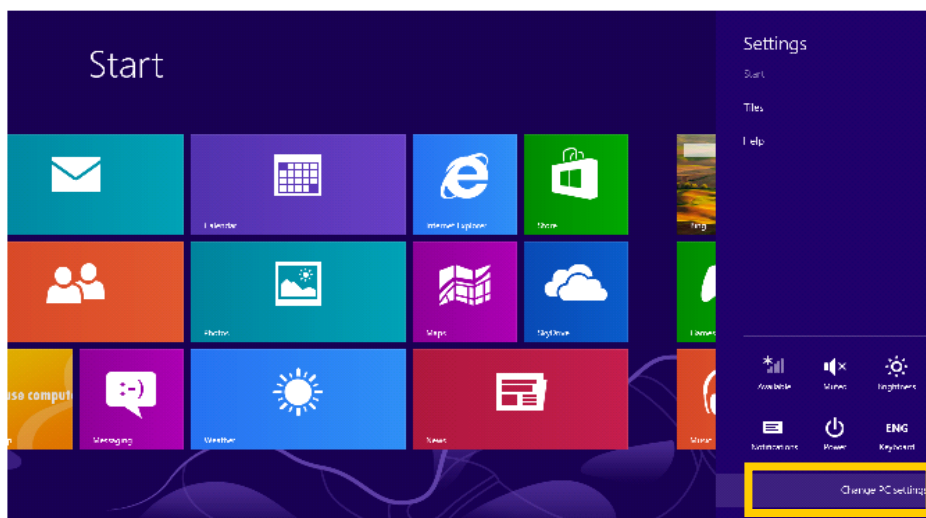

Figure 7-2 Sub menu of start screen

- c) On the PC setting screen, click the “General” and then “Restart Now” of “Advanced start-up” on the list.

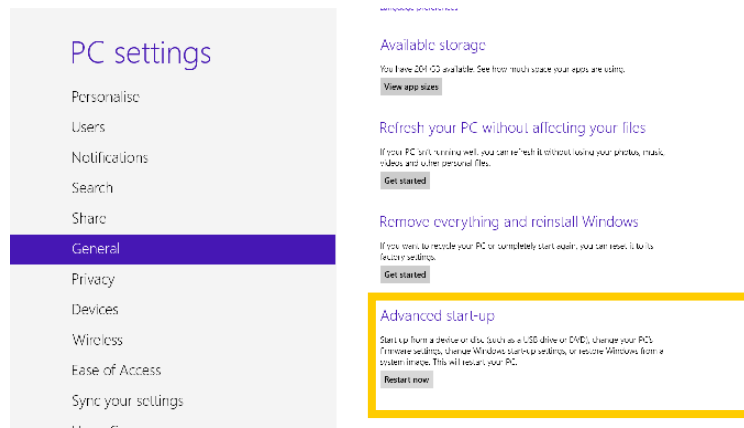

Figure 7-3 PC Setting screen

- d) Wait for the system to restart.
- e) On the option selection screen, click the “Troubleshooting” → “Detailed Options” → “Startup setting” in order.



Figure 7-4 Option selection screen

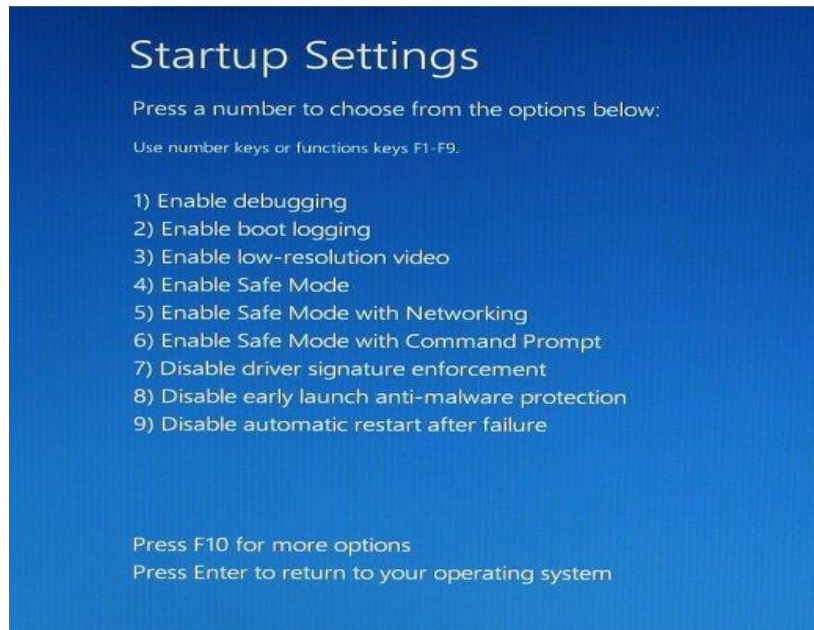

Figure 7-5 Startup setting screen

- f) Click restart and wait for a while.
- g) When startup setting is displayed, press F7 or 7.

After completing the setup, follow the process described in section 7.4.2 to install the driver. To view the device manager used in the process, right click the mouse button on the empty start window panel and click on the “all applications” and click on the “device manager”. Start from Step 4 (page 78) of installation process for Windows7 described in section 7.4.2 to complete the driver installation.

7.4.2 Installing the driver in Windows 7

It is required to install USB driver when UAM is connected first time to USB port of a PC. Follow the steps described below to complete the driver installation before running UAM Configurator application on Windows7 operating system.

Step 1: Connect UAM to USB port of the PC. Following error message will appear on the screen.

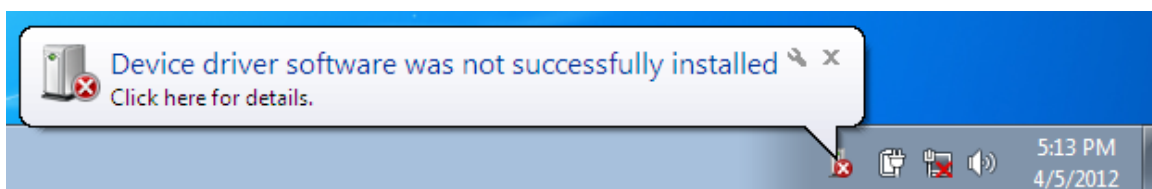

Figure 7-6

Step 2: From windows start menu click [Computer].

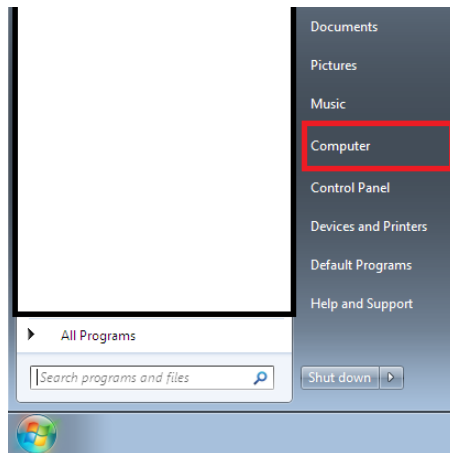

Figure 7-7

Step 3: Click [System properties] on the menu.

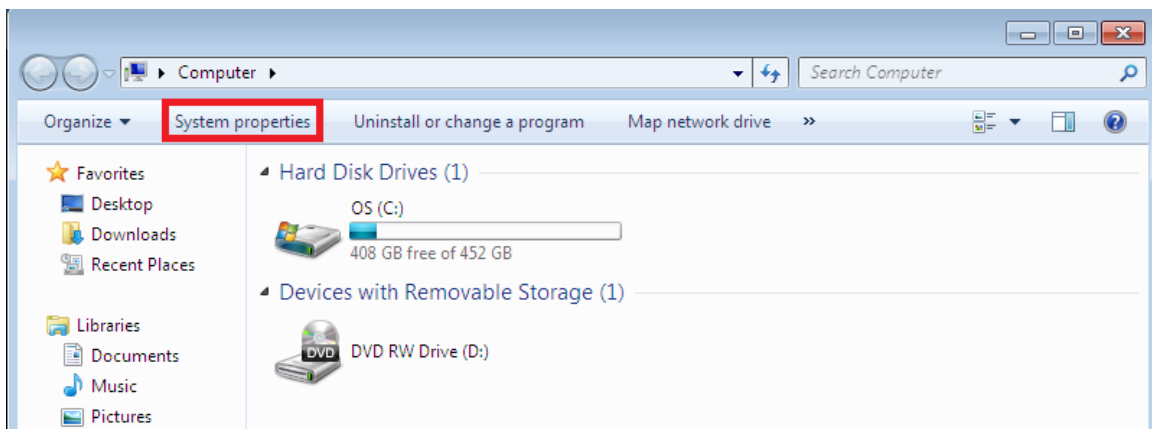

Figure 7-8

Step 4: Click [Device Manager] button.

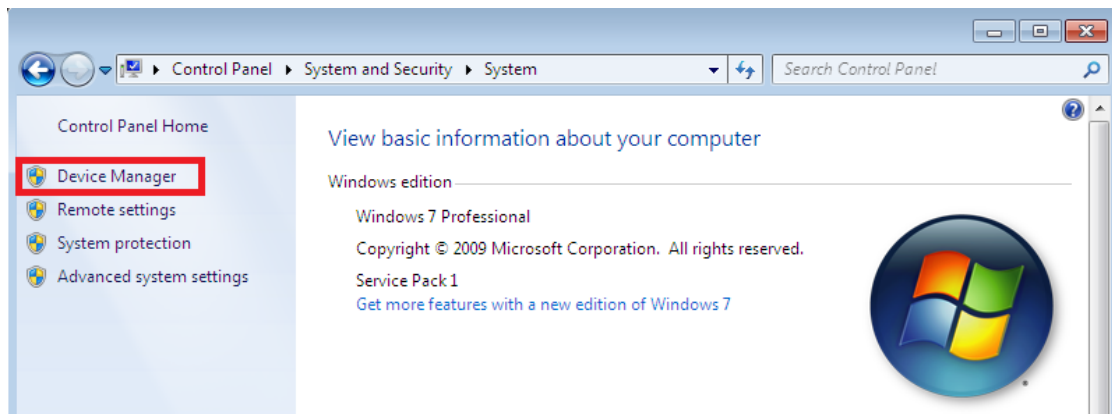

Figure 7-9

Step 5: [URG-Series USB Driver] will be listed on [Other devices]. Right click on the [URG-Series USB Driver] and click [Update Driver Software].

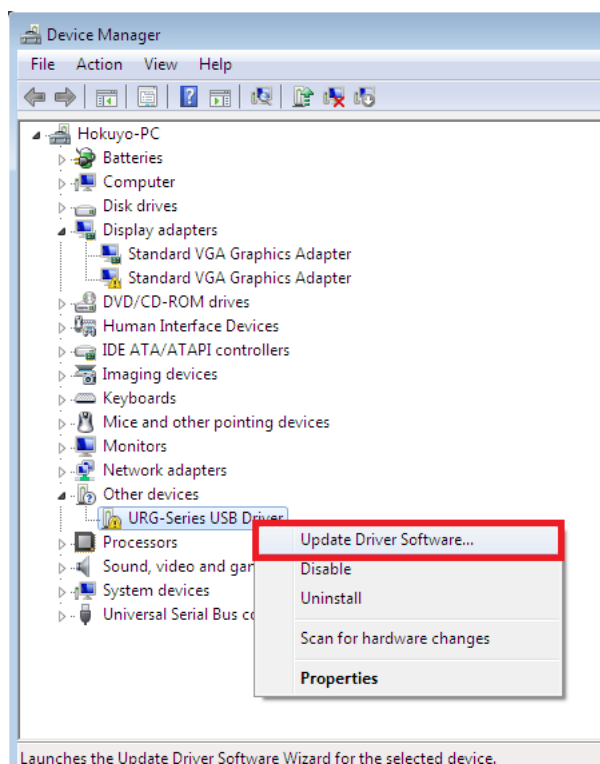

Figure 7-10

Step 6: Select [Browse my computer for driver software] when following message appears.

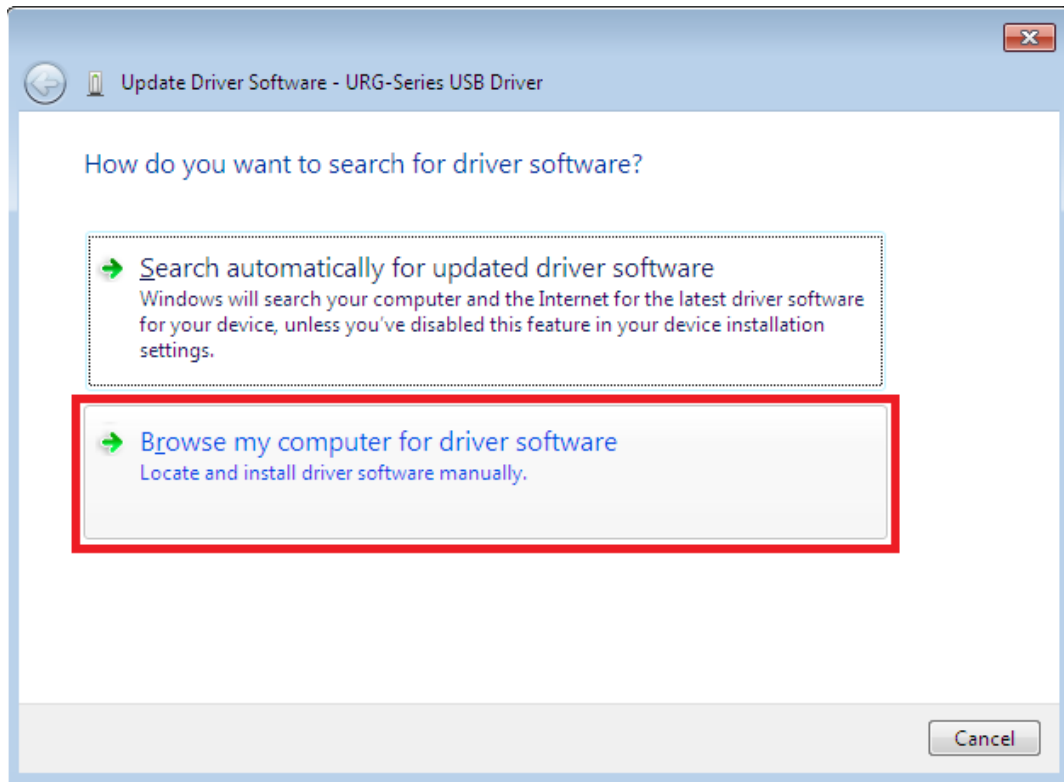

Figure 7-11

Step 7: Insert installation CD on the PC. Click [Browse] button to select “Driver” folder in the CD and click [Next] button.

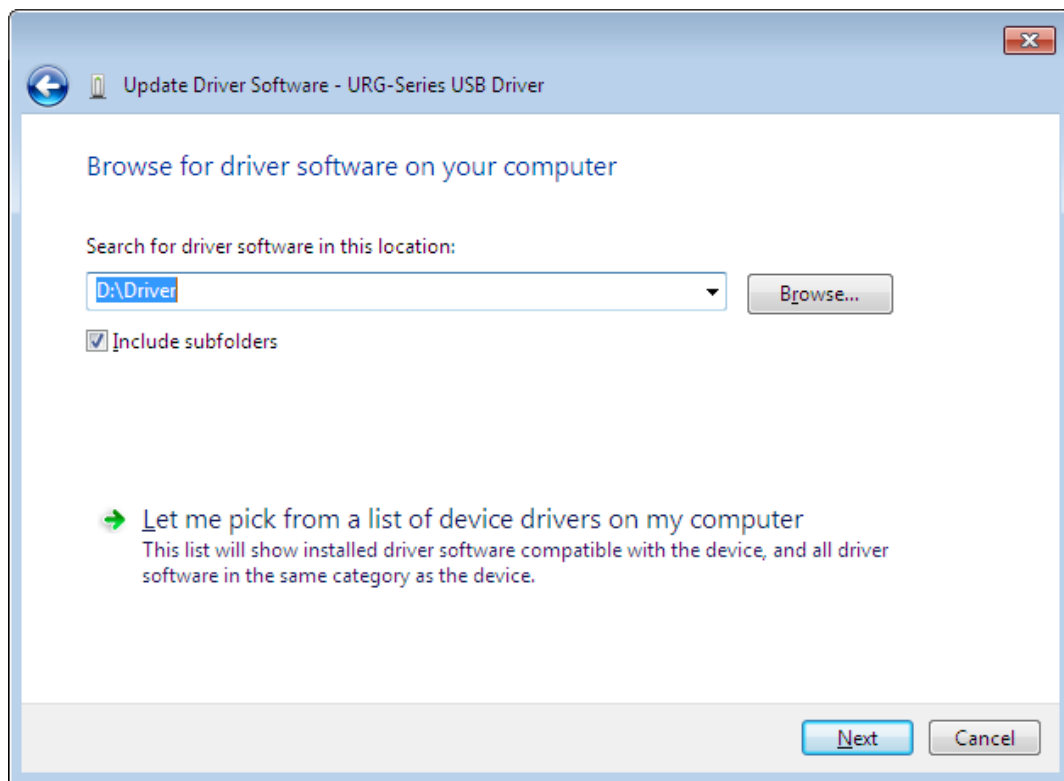

Figure 7-12

Step 8: Select [Install this driver software anyway] if following security message appears during installation.

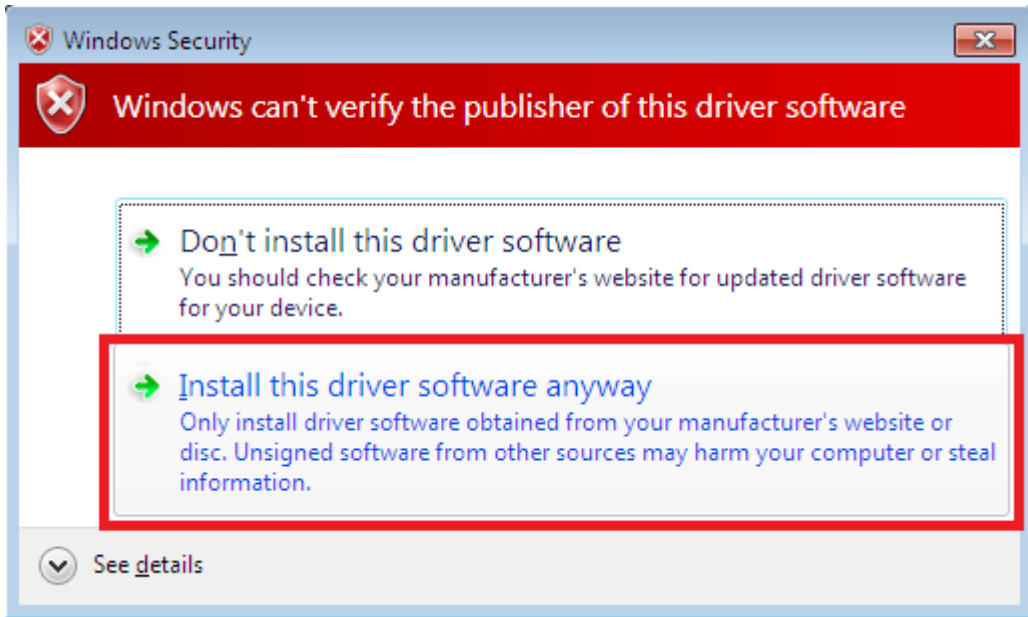

Figure 7-13

Step 9: Installation is complete when following message appears on the screen

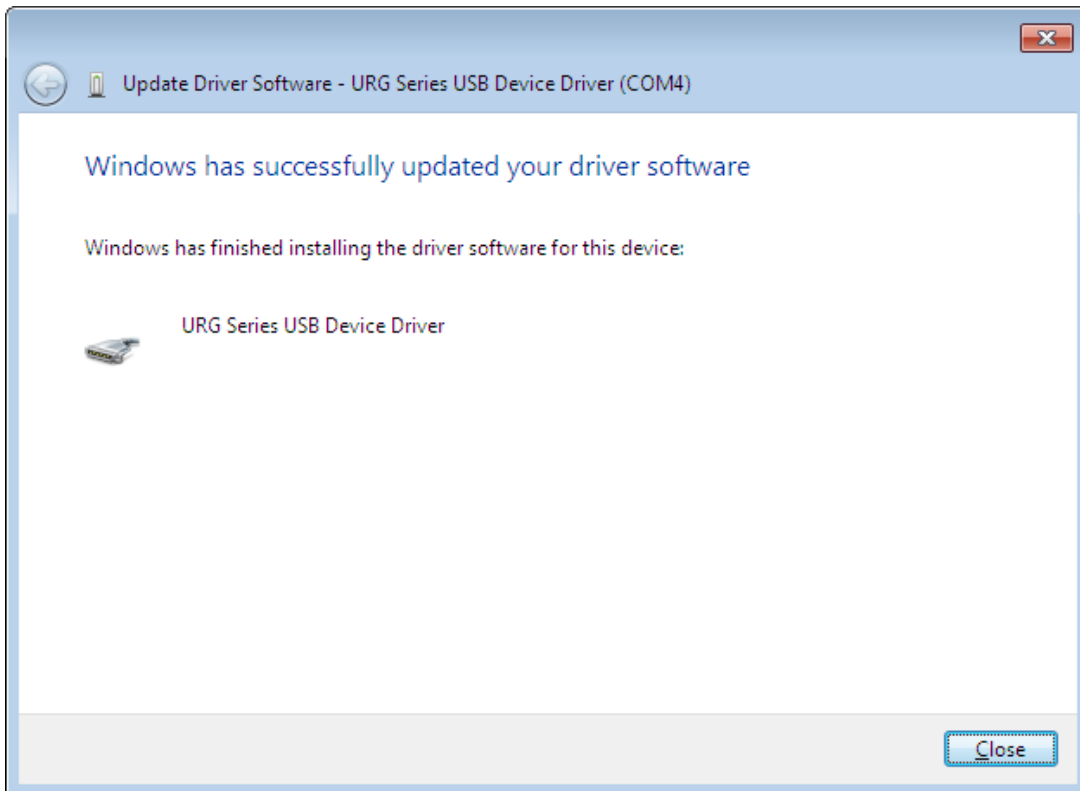

Figure 7-14

Step 10: Open device manager and confirm the presence of [URG Series USB Device Driver] listed under [Ports (Com & LPT)]

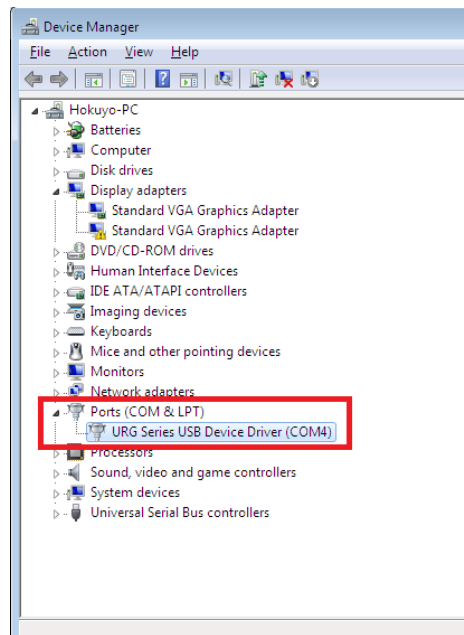

Figure 7-15

7.4.3 Installing the driver in Windows XP

This section explains the USB driver installation method in Windows XP. URG series USB driver is used by UAM. Follow the steps below to install the driver.

- a) Connect the UAM to PC's USB port. When PC detects the new hardware open the "Found New Hardware Wizard"
- b) Select "Install from a list or specific location (Advanced)". Insert the CD and click [Next>]
- c) Select "Search for the best driver in these locations". Select "Include this location in the search", and click [Browse]
- d) Select the "Driver" folder and click [OK]
- e) Click [Next>]
- f) The Wizard starts searching for the driver and dialogue box is shown.
- g) Windows starts installing the UAM driver.
- h) After clicking [Finish], the dialogue appears indicating new hardware is successfully installed.

To confirm the successful installation go to computer's device manager and expand the "Ports (COM and LPT)" list. "URG Series USB Device Driver" should appear as one of the COM ports.

7.4.4 Installing the driver in Windows 10

This section explains the USB driver installation method in Windows 10. UAM can be connected with the

pre installed USB serial device driver in Windows 10. Therefore, installing the driver provided in the package (URG Series USB Device Driver) is not necessary. Follow the steps before to install the windows USB serial device driver.

Switch on the power supply to UAM and connect it with USB cable to Windows 10 PC. OS will automatically detect the device and install the USB serial device driver. To verify the installation, open the device manager, open the lists on “Ports (Com & LPT)” and look for “USB Serial Device (ComXX)” (Figure 7-16). Use this com port number when connecting with UAM Project Designer.

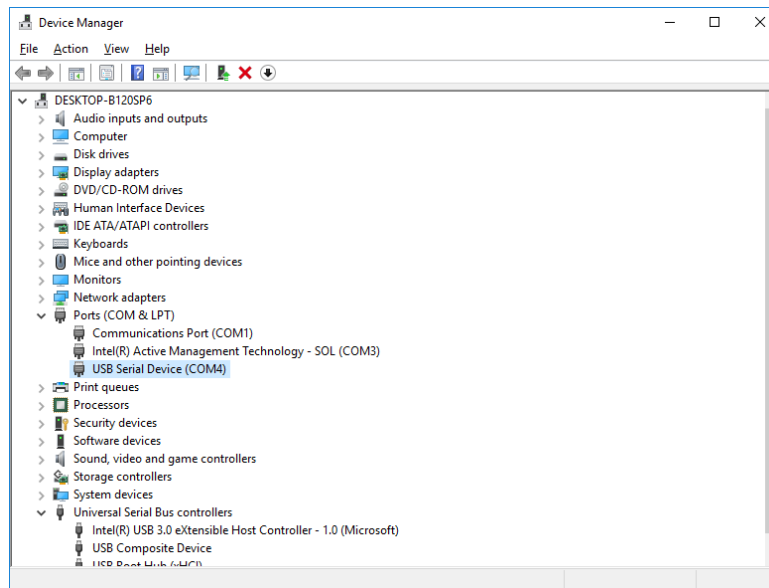



Figure 7-16 USB Driver in Windows 10

7.5 Starting the UAM Project Designer

* Explanation of this section is based on Microsoft Windows XP. Although the display may differ slightly in the other OS, same operation can be performed.

- a) Supply the Power to the sensor. Connect USB cable of the sensor to the computer.
- b) Click “ Start Menu” → “All Programs” → and click “UAM Project Designer”.
- c) “UAM Project Designer” application will be activated.

7.5.1 Startup Main window

- a) Main window as shown in figure 7-17 will be displayed when UAM project designer starts.

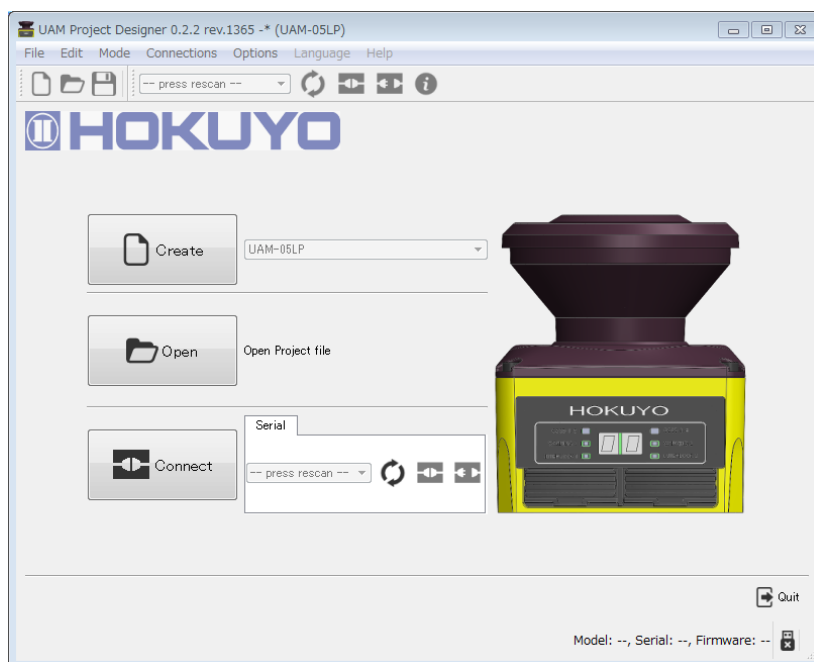

Figure 7-17 Main window

b) Select the method to operate UAM.

Table 7-2 Operating Method

Method	Description
Create	Checks the firmware version and creates a new project file for UAM.
Open	Opens an existing project file or the measurement data file
Connect	Establish communication between PC and sensor.

7.5.2 Create new configuration

When new is selected, a list of application examples as shown in Figure 7-18 will be displayed. Refer to section 4 for the details on these applications and section 4.11 for the default setting values selected by the application. Window as shown in Figure 7-19 will appear when any one of these applications are selected.

Enter the necessary information such as product identity, user name and click function to continue the setting.

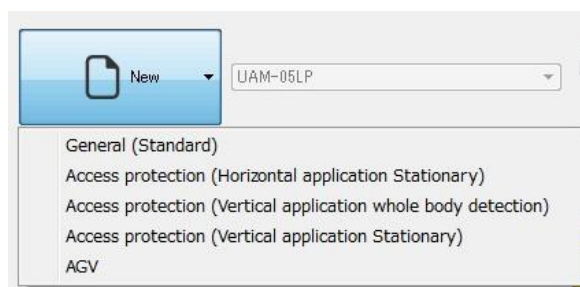

Figure 7-18 Application selection window

To change the IP address of UAM, enter the value in the Ethernet information.

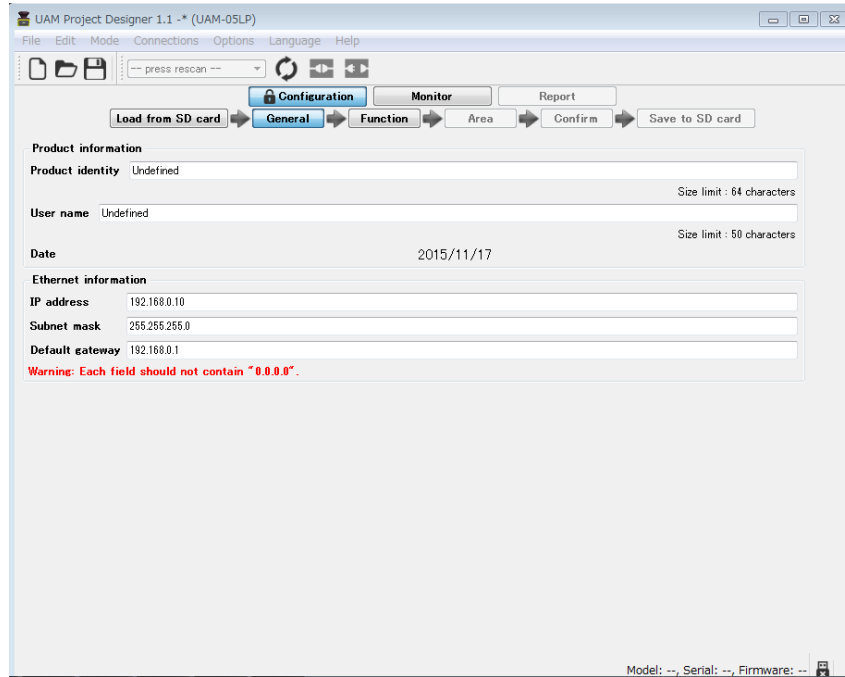

Figure 7-19 New configuration window

7.5.3 Open configuration file or measurement data file

When the open is selected, a window as shown in figure 7-20 will be displayed. Select the previously saved project, click open to read the settings. Modify the settings if required. Confirm all the settings and proceed to transmit to transfer the configuration to UAM.

Further, it also allows to open and play back the measurement data file when the “Log file (*.dslx)” is selected in the “File Type” drop down menu.

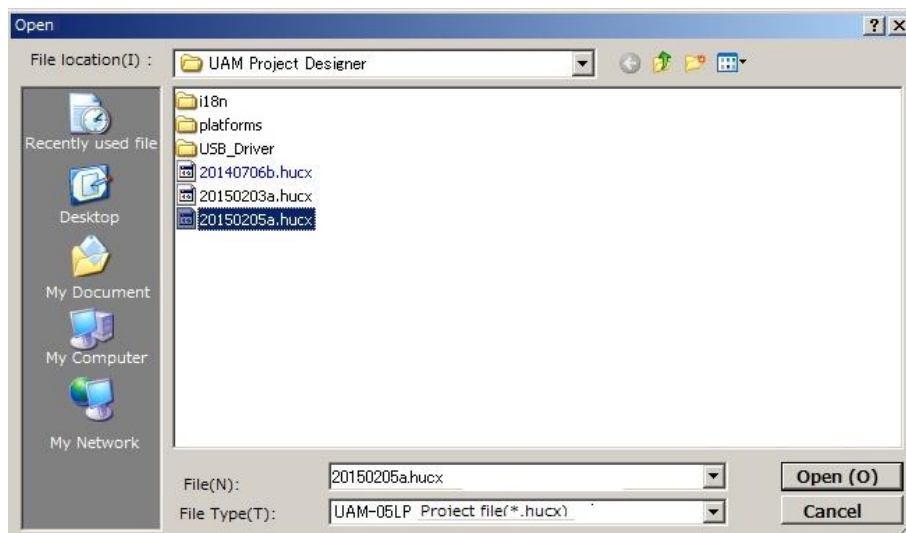

Figure 7-20 Selection of project file

7.5.4 Connect to UAM

When Connect button is selected, a window as shown in figure7-21 is displayed indicating the information are being read from UAM. When the settings are successfully read, UAM project designer will switch to

monitor mode.

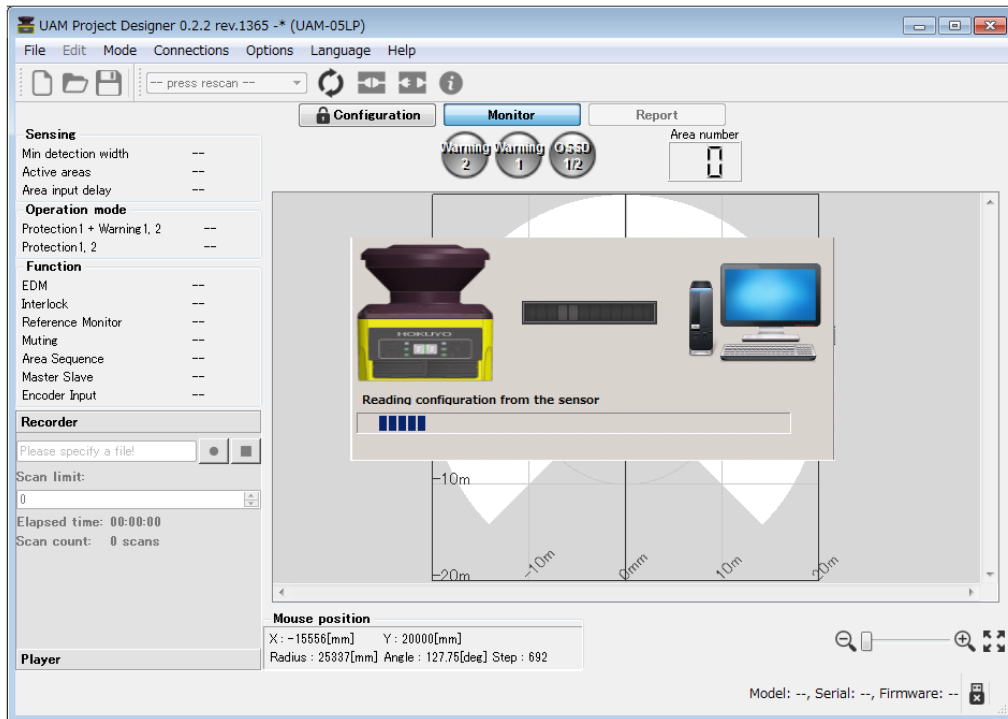

Figure 7-21 Connecting with UAM

7.6 Components of UAM Project Designer

Figure 7-22 shows the name of each component on the main window.

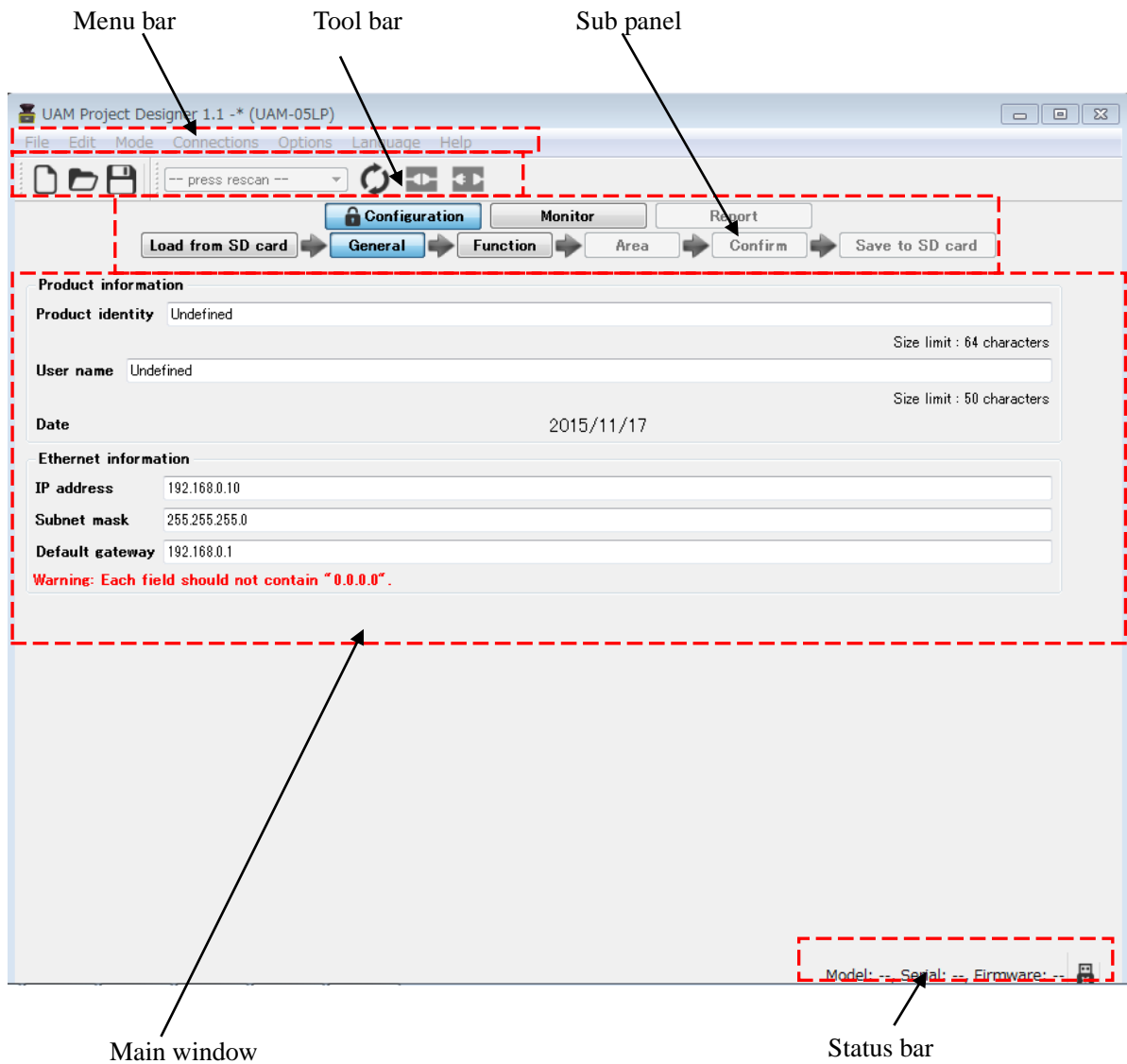
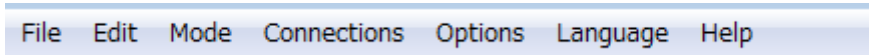

Figure 7-22 UAM Project Designer components

7.7 Menu bar

This section explains the functions of all items in the menu bar. Function can be executed by either clicking the respective items or by the short-cut key. When UAM is not connected, some items are in gray and cannot be clicked



7.7.1 File

This menu is used for creating and saving the project file and closing the application. When file is clicked, items as shown in the figure 7-23 will be displayed. Table 7-3 displays the details of each item.

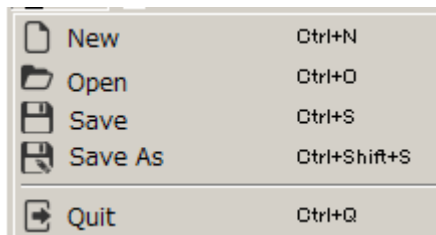

Figure 7-23 File menu

Table 7-3 File menu

Item	Short-cut Key	Function
New	Ctrl+N	Create a new configuration file for UAM
Open	Ctrl+O	Open an existing configurations file
Save	Ctrl+S	Save the current project file
Save As	Ctrl+Shift+S	Save the current project file after naming
Quit	Ctrl+Q	Close the UAM Project Designer

7.7.2 Edit

This menu is used for editing the area. When edit is clicked, items as shown in the Figure 7-24 will be displayed. Table 7-4 displays the details of each item.

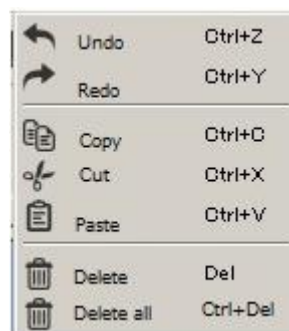

Figure 7-24 Edit

Table 7-4 Edit

Item	Short-cut Key	Function
Undo	Ctrl+Z	It will undo the previous operation.
Redo	Ctrl+Y	It will redo the last operation.
Copy	Ctrl+C	Copy single area.
Cut	Ctrl+X	Cut single selected area. Delete the original area.
Paste	Ctrl+V	Paste the selected area in other area.
Delete	Del	Delete the single selected zone.
Delete all	Ctrl+Del	Delete all the selected area.

7.7.3 Mode

This menu is used for changing the mode of the UAM. Items in the menu are shown in Figure 7-25. Function of each mode as shown in the Table 7-5.

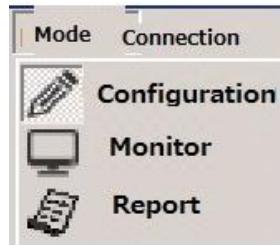

Figure 7-25 Mode

Table 7-5 Mode

Item	Function
Configuration mode	Configure the UAM settings
Monitor mode	Monitor the UAM operation.
Report	View UAM setting and error information

7.7.4 Connection

When connection is clicked, items as shown in the Figure 7-26 will be displayed. Table 7-6 shows the details of each item. When UAM is not connected these items are in gray and cannot be selected.

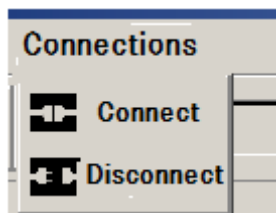

Figure 7-26 Connection

Table 7-6 Connection

Item	Short-cut key	Function
Connect	—	Connects to UAM
Disconnect	—	Disconnects UAM

7.7.5 Option

When option is clicked, items as shown in the Figure 7-27 will be displayed. Table 7-7 shows the details of each item. When UAM is not connected some items are in gray and cannot be selected.

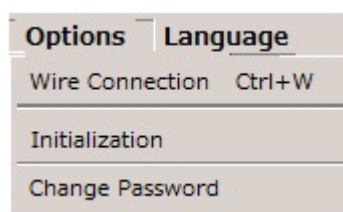

Figure 7-27 Option

Table 7-7 Option

Item	Short-cut key	Function
Wire Connection	Ctrl+W	Wire color and function assignment
Initialization	—	Clear UAM'S configurations to default
Change Password	—	Change to new 8-digit numeric password

7.7.6 Language

This menu is used for changing the application language to English or Japanese. Items in the menu are shown in the Figure 7-28. Table 7-8 shows the details of each item.

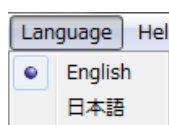

Figure 7-28 Language

Table 7-8 Language

Item	Function
日本語	Displays in Japanese language
English	Displays in English language

7.7.7 Help

When help is clicked, items as shown in the Figure 7-29 will be displayed. Table 7-9 shows the details of each item.

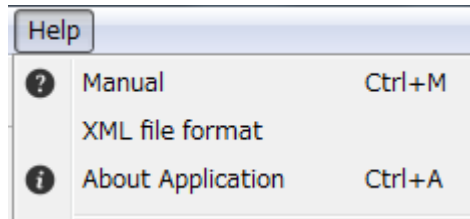

Figure 7-29 Help

Table 7-9 Help

Item	Short-cut key	Function
Manual	Ctrl+M	Displays the user manual
XML file format	-	Displays format details of XML file
About the application	Ctrl+A	Displays the version details of UAM Project Designer

7.8 Tool bar

Frequently used functions are listed on the tool bar. Details of the item are shown in table 7-10. When UAM is not connected some items are displayed in gray and cannot be selected

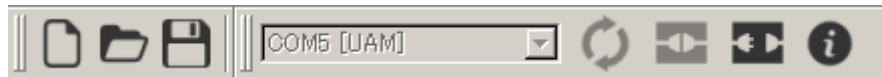









Table 7-10 Tool bar

Icon	Function
	Creates a new configuration file for UAM
	Opens a saved file.
	Saves the project file.
	Displays the port number connected to UAM.
	Rescan the USB port
	Establish connection between the sensor and UAM Project Designer.
	Disconnect sensor with UAM Project Designer.
	Sensor information

7.9 Subpanel

This subpanel is used for switching the UAM modes (Configuration, Monitor and Report). When items cannot be used they are displayed in gray.



7.9.1 Configuration tab

There are 6 tabs under the configuration main tab (Load from SD card, General, Function, Area, Confirm and Save to SD card). Users can configure UAM by sequentially selecting these tabs.

A) Load settings

User can read the settings from UAM or SD card. Loading the settings from UAM is possible only if it is connected with the application. If it is not connected SD card selection window will appear. Select the SD card location to load the settings.

B) General

User can set the product identity, user name and IP address of UAM.

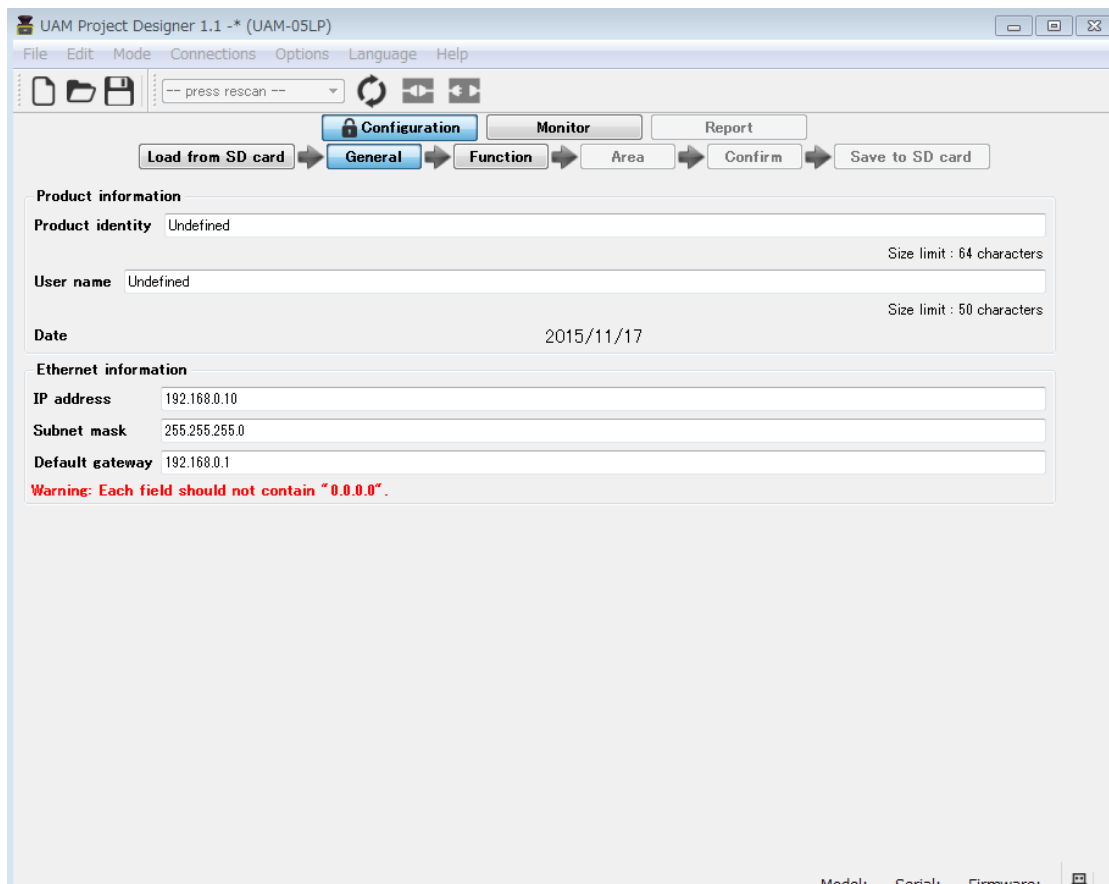

Figure 7-30 General

Table 7-11 General

Tab	Item	Description
General	Product identity	Enter ID for UAM (Size limit : 64 characters)
	User name	Enter User name (Size limit : 50 characters)
	IP address	Set the IP address
	Subnet mask	Set subnet mask address
	Default gateway	Set the default gateway address

C) Functions

UAM functions and related parameters can be selected for configuration. See Table 7-12 for details. Setting becomes valid when the function is checked displaying the configurable parameters. Sensing is the basic setting of the sensor therefore it has no check box.

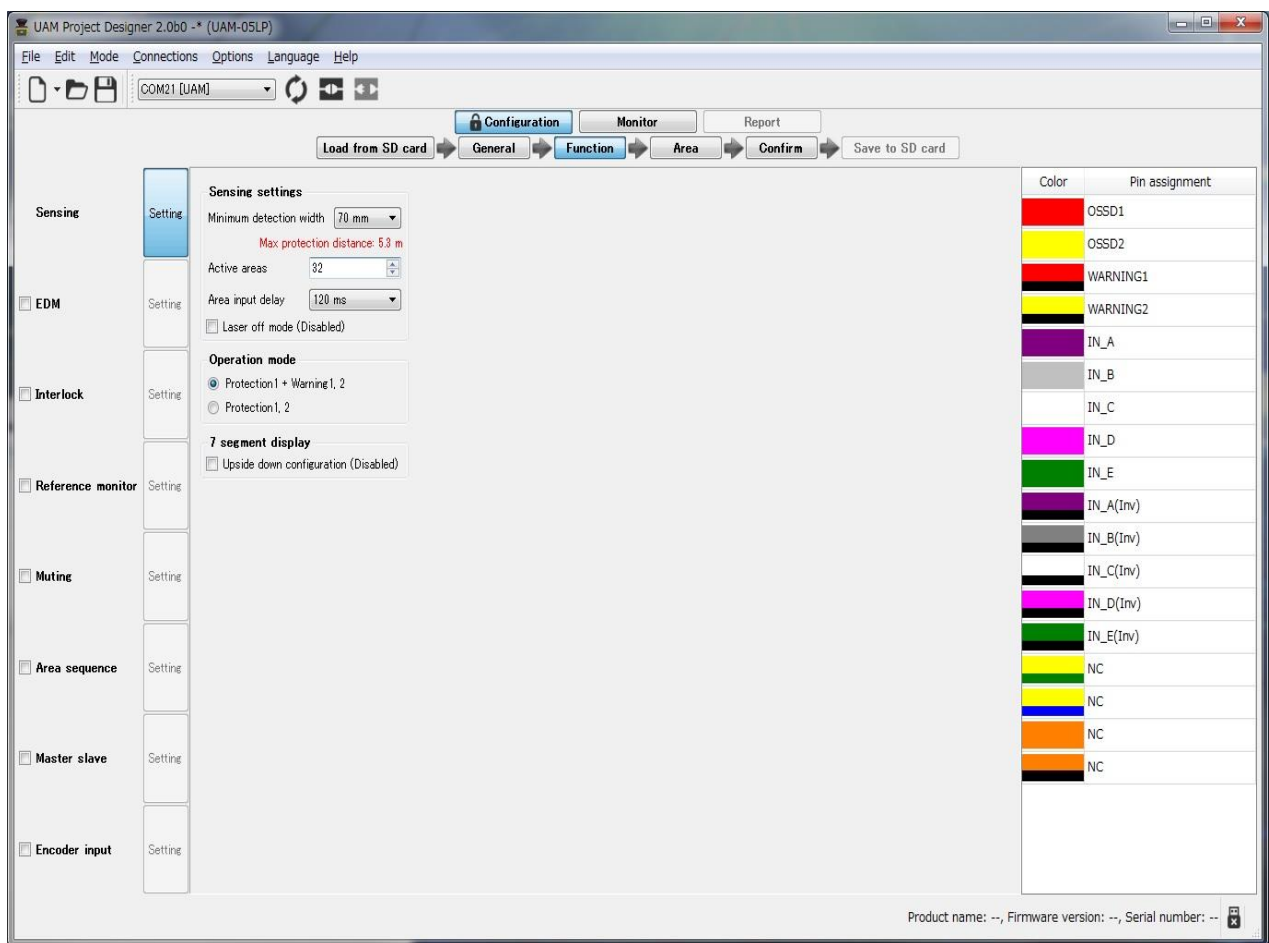

Figure 7-31 Function

Depending on the selected function, active area count and cable pin assignment are automatically changed. For functions that cannot be used simultaneously, selection of one will disable the other changing its color to gray. If selecting a function affects the other, its background is changed to yellow. Confirm the setting of these functions and make corrections if necessary.

Table 7-12 Function

Tab	Item	Description
Function	Sensing	<p>Check to enable the sensing function</p> <ul style="list-style-type: none"> ● Min detection width*¹ (mm) 30, 40, 50, 70, 150 ● Active areas*²: Area 1 to Area 32 (Area 1 to Area 128 when encoder input function is enabled) ● Area input delay :30ms (Default), 120ms, 270ms, 1s, 2s ● Operation mode : Protection 1 + Warning 1/2, Protection 1, 2 ● Laser off mode: Disable (Default), Enable ● 7-Segment display upside down configuration: Disable (Default), Enable
	EDM	<p>Check to enable the EDM function</p> <ul style="list-style-type: none"> ● On delay(ms): 90 (Default), 120, 300 ● Off delay(ms): 300 (Default), 330, 360 <p>* In dual protection mode, EDM1 and EDM2 can be configured independently.</p>
	Interlock	<p>Check to enable the Interlock function</p> <ul style="list-style-type: none"> ● Start/Restart mode: Manual/Automatic, Manual/Manual ● Delay(s): 1(Default) to 6 ● Independent setting for Master-Slave communication error: Disable (Default), Enable <p>* In dual protection mode, interlock can be independently configured for protection zone 1 and protection zone 2.</p> <p>* When the master-slave function is enabled, it is possible to independently configure the interlock setting for the master-slave communication error.</p>
	Reference monitor	<p>Check to enable the Reference monitor function</p> <ul style="list-style-type: none"> ● Tolerance(mm): 100 (Default) to 10000 ● Response time : 1s or Operating area response time
	Muting	<p>Check to enable the Muting function</p> <ul style="list-style-type: none"> ● Muting input sequence: Protection zone 1: Muting 1 → Muting 2 (Default), Muting 2 → Muting 1 Protection zone 2: Muting 3 → Muting 4 (Default), ● Muting 4 → Muting 3 Time interval between inputs(s): 1(Default), 3, 5, 10 ● Max. muting period(min): 1(Default), 6, 12 and Unlimited ● Max. override period(min): 1(Default), 6,12 <p>* In dual protection mode, muting can be independently configured for protection zone 1 and protection zone 2.</p>
	Area sequence* ³	<p>Check to enable the Area sequence function</p> <ul style="list-style-type: none"> ● The check box of the area sequence possible area will be valid ● The check box for all area will be valid



	Master Slave	Check to enable Master Slave function Current device*4: Master, (Default) Slave1, Slave2, Slave3 <ul style="list-style-type: none"> ● Slave count: 1 (Default) to 3 (For Master only) ● Use own OSSD outputs (For slave only)
	Encoder Input	Check to enable the Encoder Input function <ul style="list-style-type: none"> ● Error tolerance: 0 to 80 % ● 8 patterns (Input E Enable) ● Encoder pulse 1: 50 to 1000 (count/cm) ● Encoder pulse 2: 50 to 1000 (count/cm) ● Select patterns: Each pattern can be selected from Not Use, Use as Static input and Use as Encoder input. ● Detailed area setting for each pattern. For the encoder input set speed division count and area for each speed range. It is not possible to select same area for two different speeds. For static input, select the area and enable or disable speed monitoring. If speed monitoring is enabled it is necessary to provide the speed range.

*1: The minimum width of detectable objects. Detection is not possible if configured width is more than the object intended to be detected.

Default value of minimum width changes depending on the type of selected application. Refer to section 4.11 for the selected values.

*2: Set the number of areas to be used. Area count depends on the selected function and adjusted automatically.

Default value of active areas changes depending on the type of selected application. Refer to section 4.11 for the selected values.

*3: For each area, specify one or more area during area sequence.

*4: An error will occur if the UAM with same ID is connected to the currently operating master slave system.



D) Area

User can configure and edit area shapes. Details of each component are explained below.

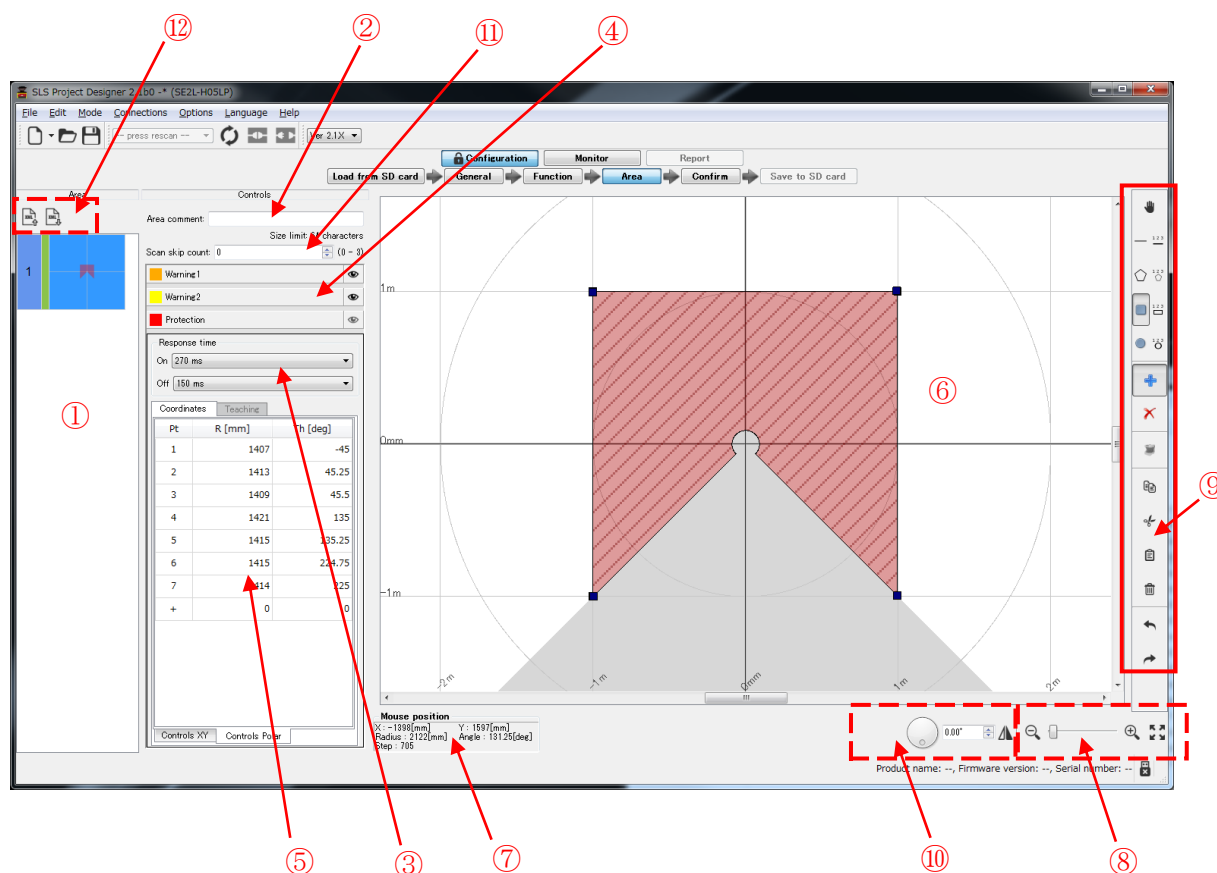

Figure 7-32 Area configuration tab

< Area >

① Area Preview

It displays the shape of each area. It is possible to edit the area when the background of the area preview is green. The area which is possible to edit is displayed in the area screen. Number on the left of area preview represents the area number. While changing area setting, the line color will change to green.

< Control >

② Area Comment

Brief explanation of each area can be entered (size limit is 64 characters).

③ Response Time (ON/OFF)

Response time of each area can be set.

④ Zone Selection

Configuration of respective zone is possible when it is selected.

⑤ Point coordinate

Displays the coordinates of configured points in the zone. They can be also edited directly.

⑥ Area Display



Shapes of all the areas are displayed.

⑦ Mouse position

If the cursor is placed on the configured area, sensor coordinate represented by the mouse pointer is displayed. Table 7-13 explains in detail.

⑧ Zoom In, Zoom Out tool

Adjust the area display screen ratio. Table 7-14 explains each icon.

⑨ Drawing tools bar

Tool icons for configuring the area shape. Table 7-15 explains each icon.

⑩ Tool for rotating and reversing the display

Tool icon to rotate and reverse the area and measurement data

⑪ Scan skip count

Scan skip count can be individually set for each area. (Refer to section 3.19 Scan Skip Function)

⑫ XML File Tool

There is an icon to import and export the XML file containing the area information. Icon details are explained in Table 7-17.

Table 7-13 Display of mouse information

Display	Description
X (mm)	Displays the mouse position of x -coordinates.
Y (mm)	Displays the mouse position of y -coordinates.
Radius (mm)	Displays the distance from the origin to the position of the mouse.
Angle (deg)	Displays the distance from the smallest angle to the position of mouse.
Step	Displays the step value of mouse position.

Table 7-14 Display adjust icons



Icon	Function
	Zoom out the main view screen. Same operation can be done by scrolling mouse down.
	Move the cursor left for zoom out and right for zoom in.
	Zoom in the main view screen. Same operation can be done by scrolling mouse up.
	Reset the view to fit the window.

Table 7-15 Drawing assistance icons





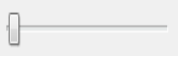











Icon	Function
	Move the configured area
	When line segment is drawn by moving the mouse, a triangular shape is drawn by connecting the two points of the line and the origin.
	When coordinates of start and end points of a line are specified numerically, a triangular shape is drawn by connecting these points with the origin.
	When multiple points are selected with mouse click, a polygon is generated by connecting these lines and the origin
	When coordinates of multiple points are specified, a polygon is generated by connecting these lines and the origin.
	When square shape is drawn by moving the mouse, a shape connecting its four edges and the origin is drawn.
	When four coordinates of square shape are numerically specified, a shape connecting these points and the origin is drawn
	When circular shape is drawn by moving the mouse, a shape connecting the arc of the circle with the origin is drawn.
	When center, radius and starting and end point of the arc are numerically specified, a shape connecting the arc of the circle with the origin is drawn.
	Specified shape is added to the area.
	Specified shape is removed from the area.
	Configure the zone by automatic teaching function
	Copy the selected area
	Cut the selected area
	Paste the area previously copied or cut.
	Delete the selected area.

Table 7-16 Rotate and reverse icon







Icon	Function
	It will undo the previous operation
	It will redo the last operation
	Rotate the area and measurement data display window
	Reverse the area and measurement data display (left to right or right to left)

Table 7-17 XML file icon

Icon	Function
	Imports area details from XML file (Check the help menu for details on XML file format)
	Exports area details to XML file.

E) Confirm

After completing all the configurations, they can be reviewed by clicking the confirm button followed by the steps shown in Figure 7-33(a) to (c). Return back to the respective tab if correction is necessary.

Click the “Transmit to sensor” button if configuration has no error to write it into UAM if it is connected or “Save to SD card” button to save the setting file into the SD card memory when UAM is not connected.

Further, the configuration data can be saved in the pdf format by clicking on the “Output PDF” button. See Table 7-18 for the saved details on the file (Note: Sensor information will not be shown in the report if the pdf file is generated without connecting to the UAM).

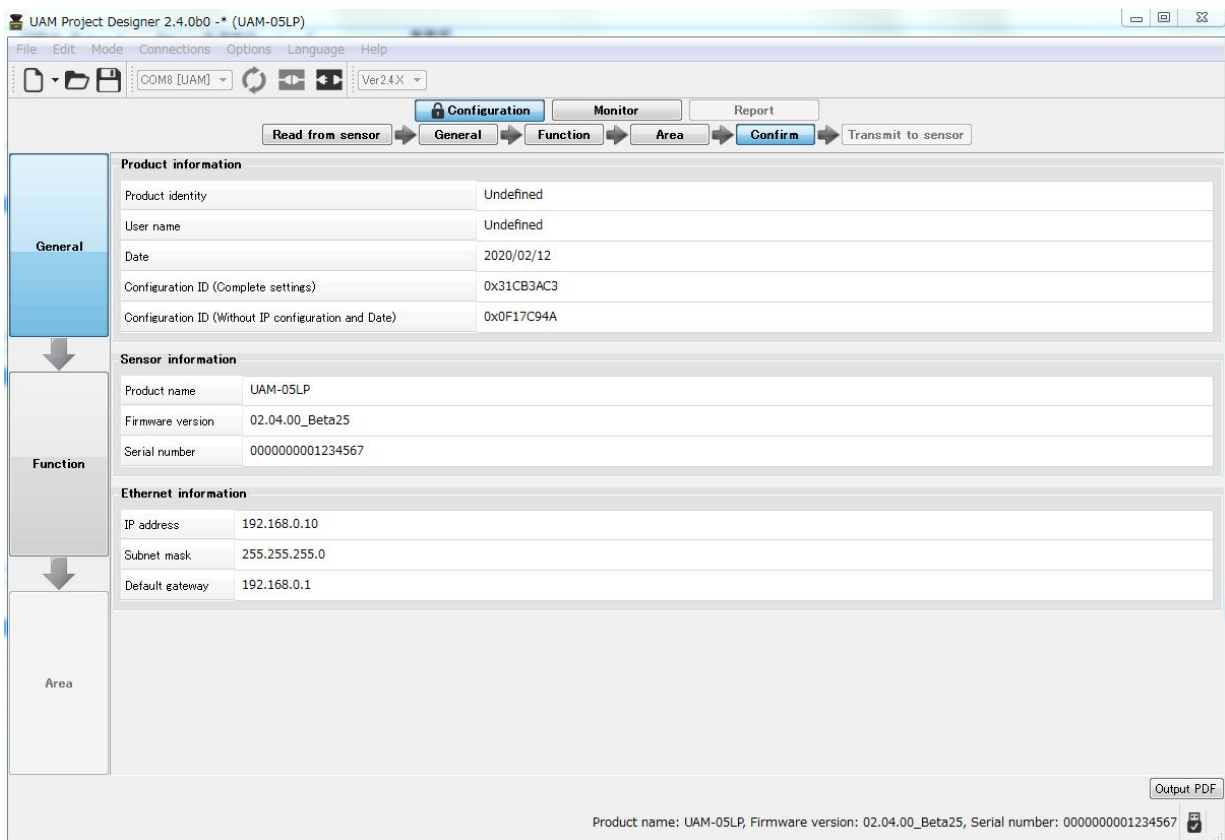

Figure 7-33(a) General

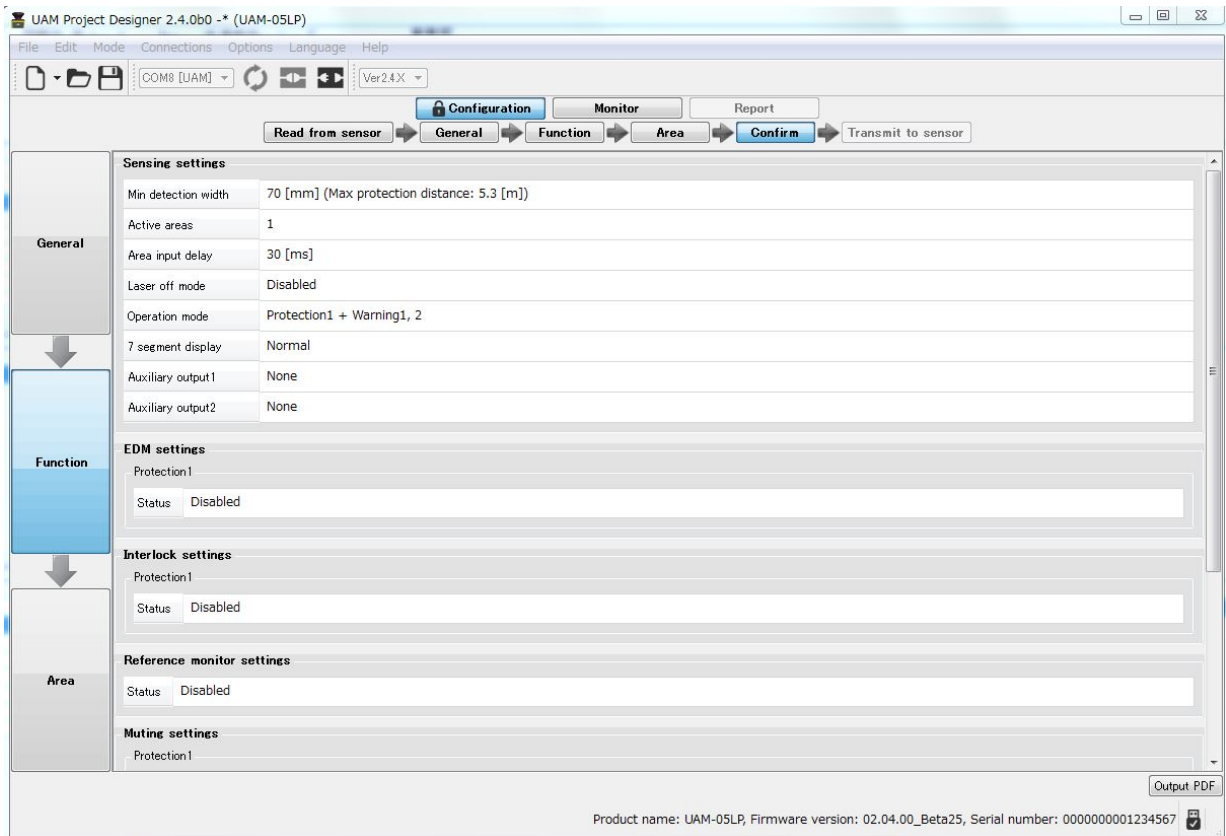
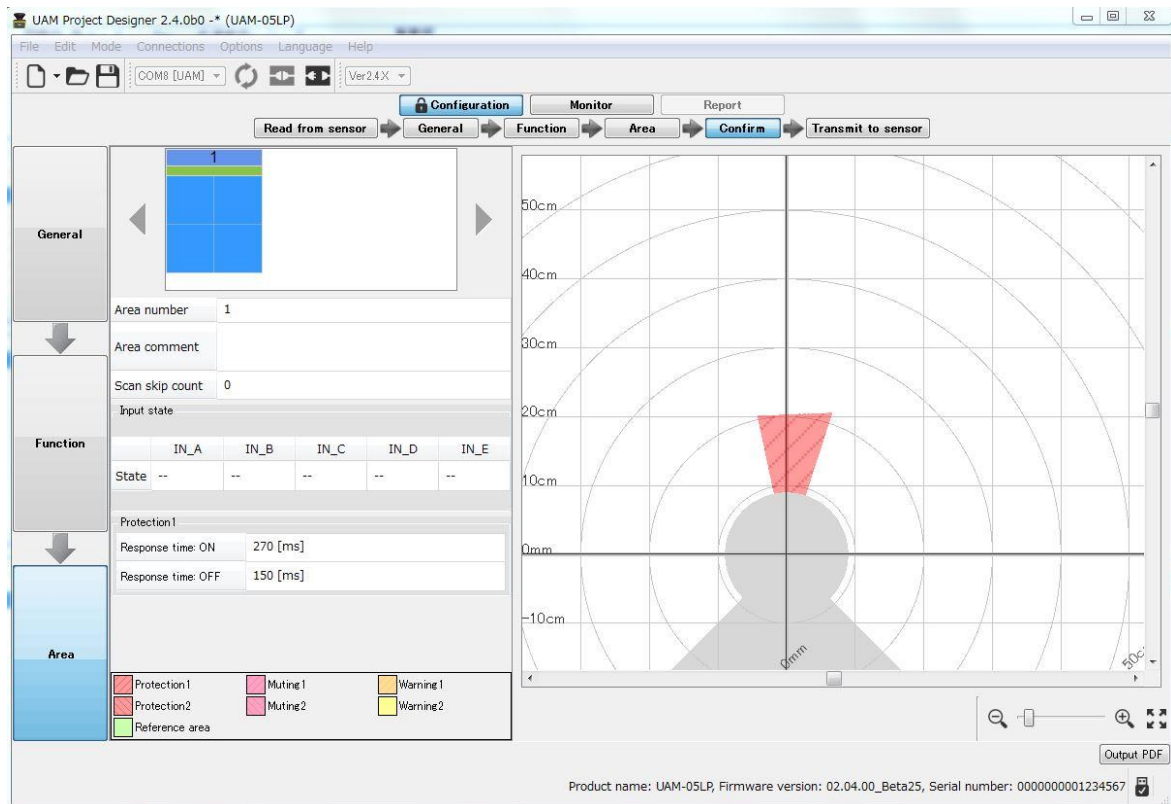

Figure 7-33(b) Function



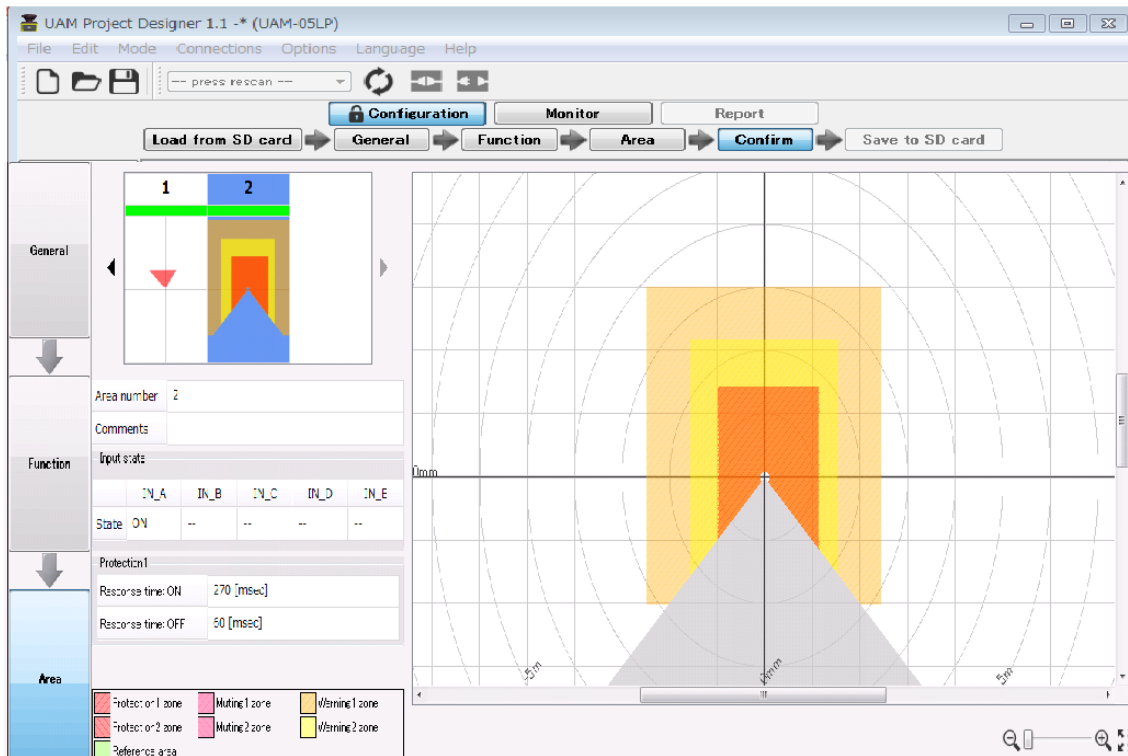

Figure7- 33(c) Area

F) Transmit to sensor/ Save to SD card

Click “Transmit to sensor” button if error is not found during confirmation to transmit the configuration to the UAM. If device is not connected, click “Save to SD card” button to save the setting file into the SD card memory.

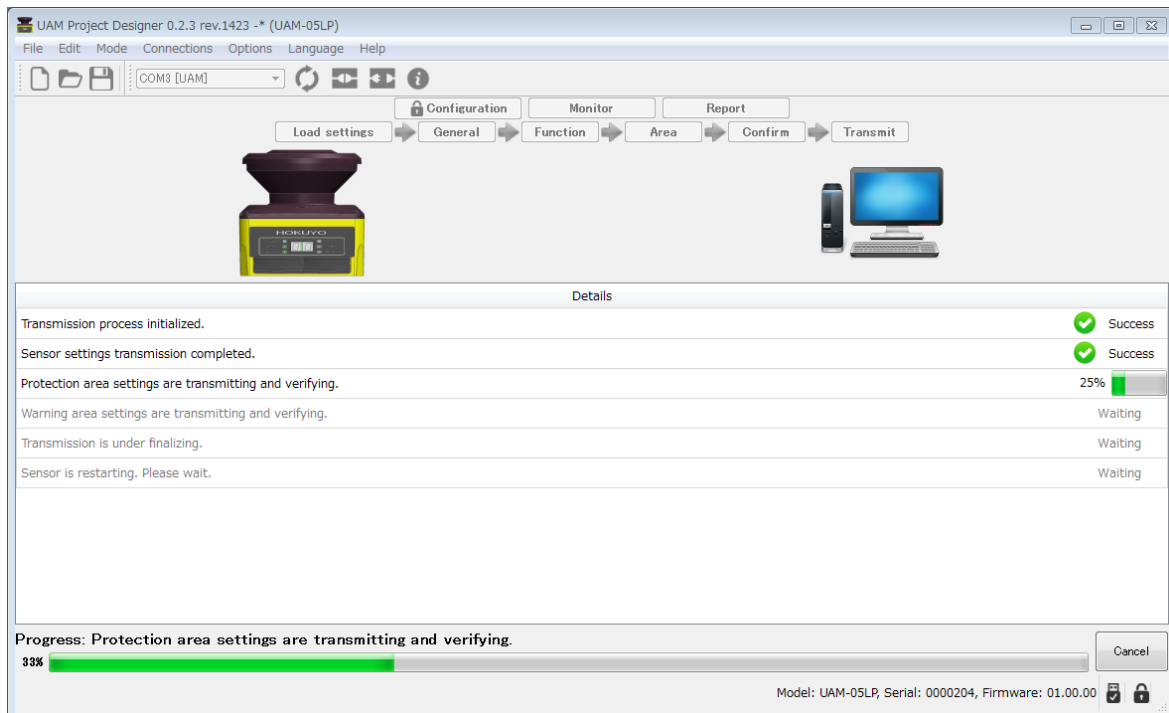

Figure 7-34 Transmit window

Depending upon the computer's performance it may take few minutes to transfer the configuration. When transferring process is completed, UAM will restart automatically.

7.9.2 Monitor tab

User can monitor the detection state of the UAM by selecting the monitor tab.

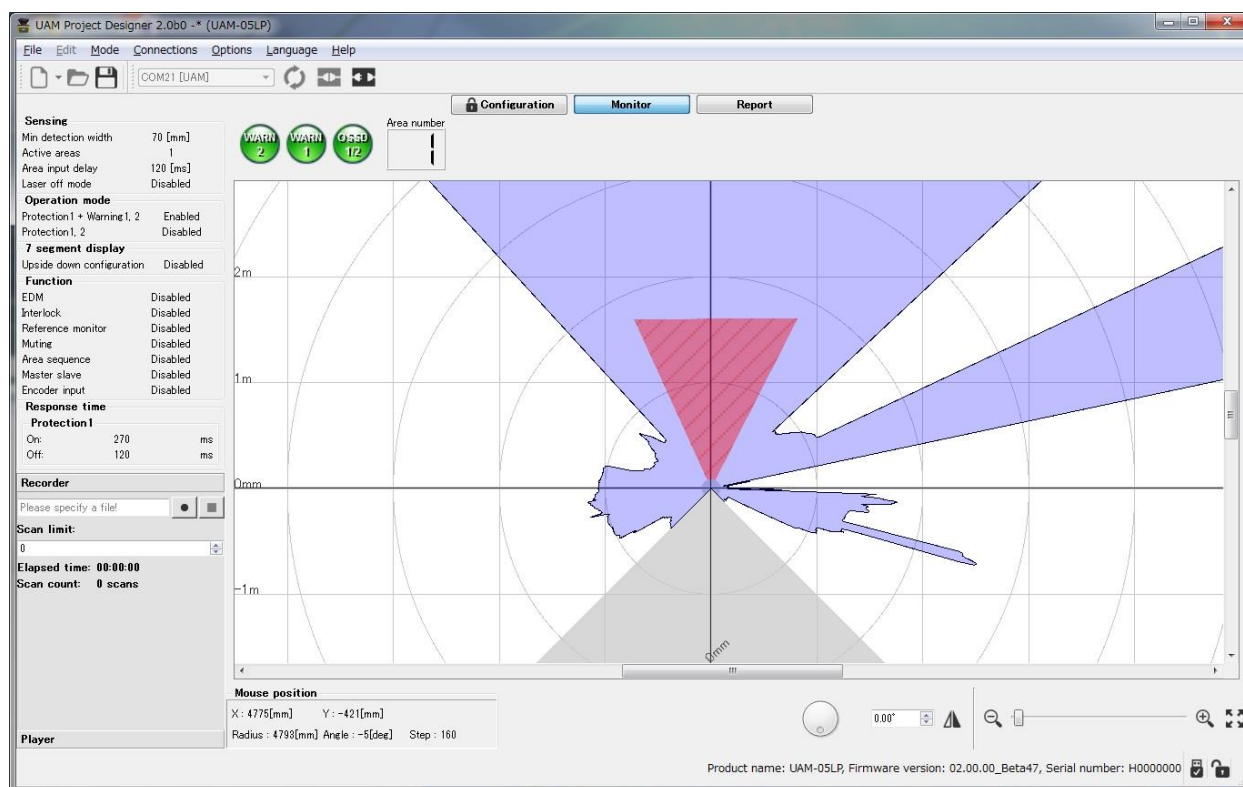







Figure 7-35. Monitor tab

Following icons appear in the monitor window

Icon	Function
	Indicates the states of the OSSD1,2 and OSSD3,4 signals. Green: ON (No detection) Red: OFF (Detection)
	Indicates the states of the warning signals WARNING1, WARNING2 Green: ON (No detection) Red: OFF (Detection)
	Indicates the operating area number
	Indicates the error number when error is detected. (See section 9 for the details)
	Indicates the contamination on the optical window (See section 3.20 for the details)

7.9.3 Report tab

Report tab is only functional when the UAM is connected to the application. There are 3 types of reports: Project report, Error report and Detection Log report. Project report includes the UAM's configurations. Error report includes error recorded during the operation and past errors. Detection Log reports displays the history of object detected in the protection zone. For detail on report tab items refer to Table 7-18. User can save reports in PDF format by clicking the [Output PDF] button. When clear button is clicked all the records are deleted from the sensor. When refresh button is clicked latest information are updated from the sensor.

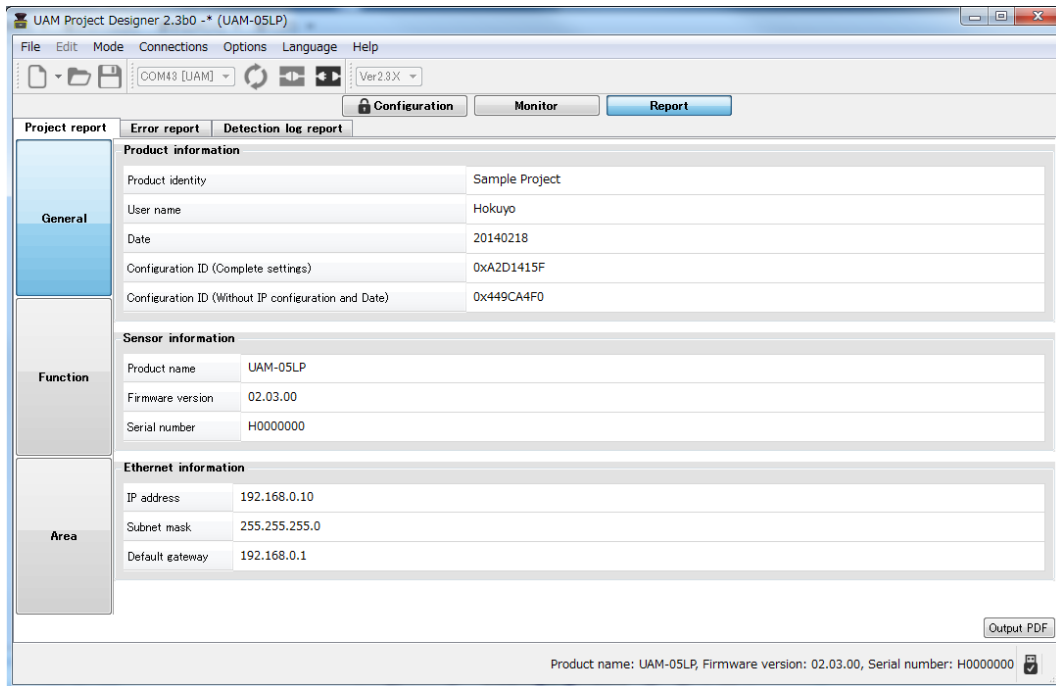

Figure 7-36(a) Project report tab

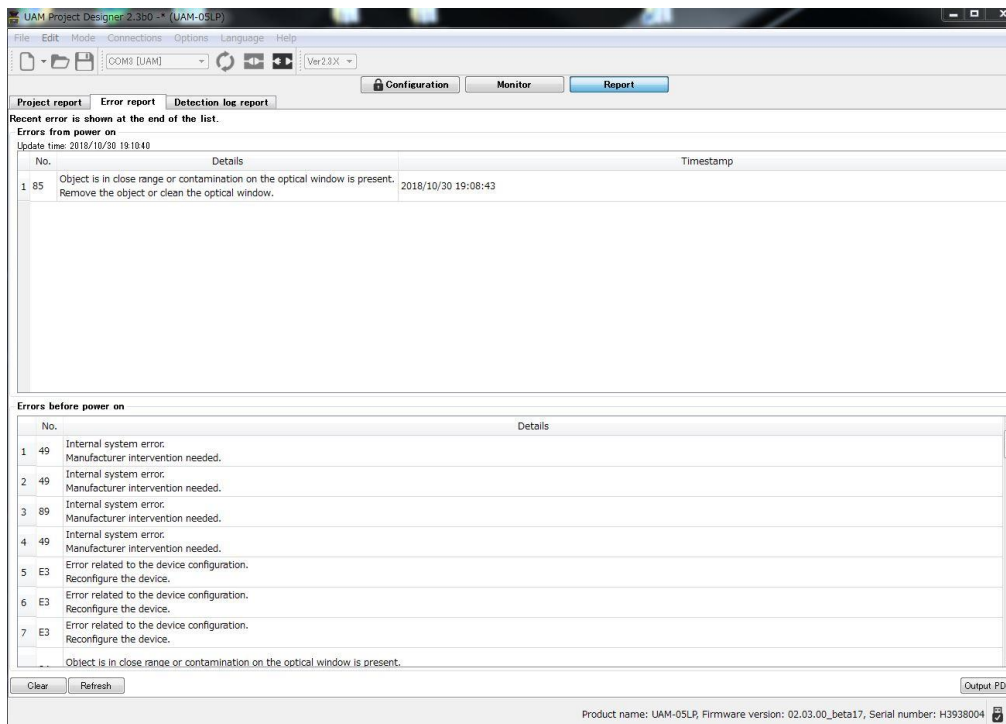

Figure 7-36(b) Error report tab

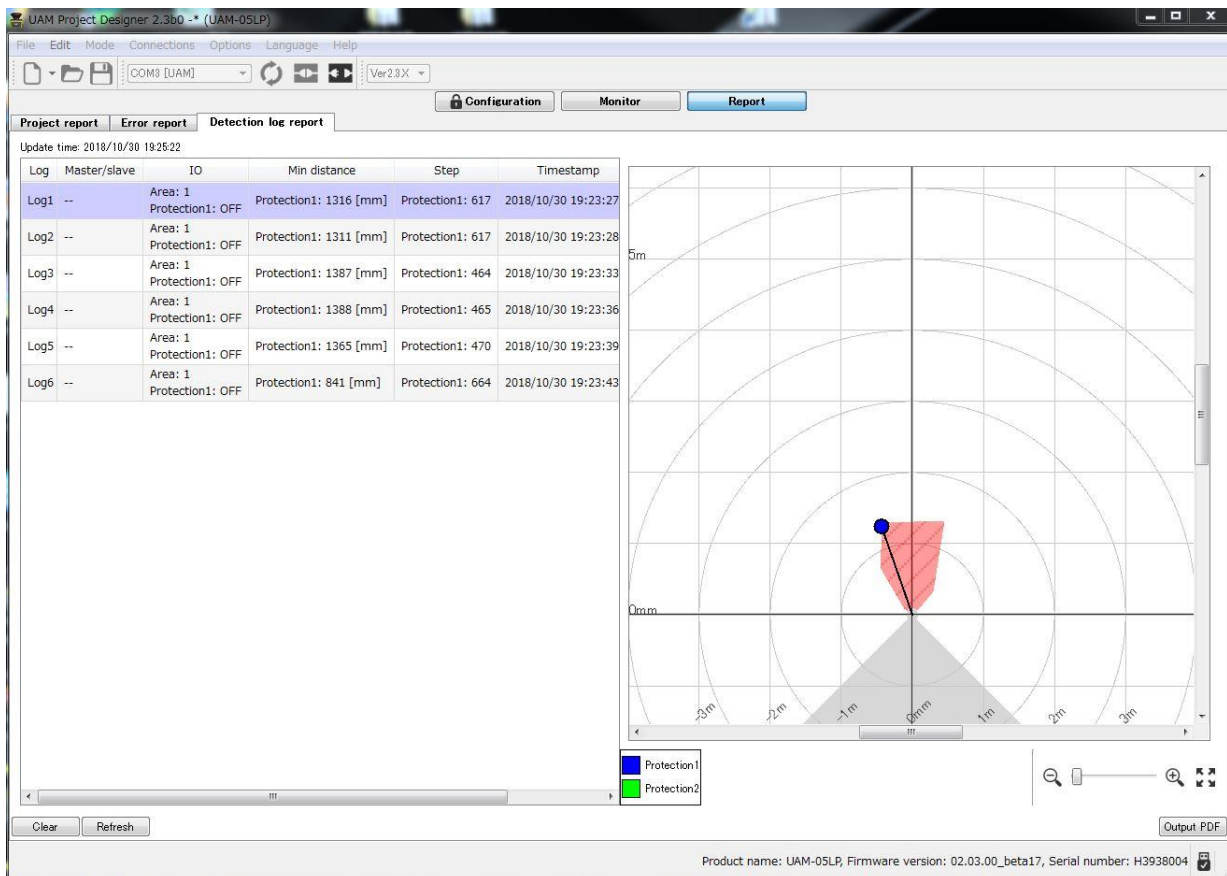

Figure 7-36(c) Detection log report tab

Table 7-18 Report display items

Report	Items show in report
--------	----------------------

Project	<ul style="list-style-type: none"> ● Product identity ● User name ● Date ● Sensor information ● Configuration ID (Complete setting and Without IP configuration and Date) ** ● Ethernet information ● Sensing ● Operation mode ● EDM ● Interlock ● Reference monitor ● Muting ● Area sequence ● Encoder input ● Static area input ● Encoder area input ● Master slave ● Area information
Error	Error report includes error recorded during operation.
Detection log	Detection status during the operation (Area, Minimum distance, steps, time stamp)

* Report is in PDF format. To view the report, Adobe Reader® or any equivalent application software is required. Free version of Adobe Reader® can be downloaded from the website: <http://www.adobe.com>.

** Configuration ID is a unique identification code of the configured settings in the device. Configuration ID is generated when the device is configured for the first time and every time it is reconfigured. It is saved in the project report along with the other information. It can be used to verify the unintentional modification of the device.

Configuration ID (Complete Settings): ID generated will include all the configurable parameters including Ethernet IP settings and the Date.

Configuration ID (Without IP configuration and Date): ID is generated without the Ethernet IP and the Date. It is useful when managing multiple device that have same configuration but different IP address and/or configured date.



7.10 Status bar

This section displays the model, serial number, firmware version of the connected sensor. Icons on the right show connection state. Table 7-19 explains the meaning of each icon.

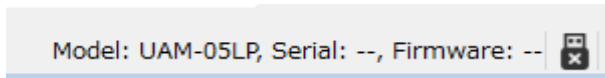

Table 7-19 Status bar icon

Icon	Description
	Indicates the connected state with UAM.
	Indicates the disconnected state with UAM.

7.11 Connecting UAM with PC

- Supply the power to UAM and connect with PC through USB cable.
- When connection is established application will automatically detect the UAM and displays its COM port. If it is not displayed, click rescan icon on the toolbar to refresh the COM port.
- Click connect device icon on the tool bar and enter the password when dialog appears (refer to section 7.12).
- Connection status is shown on the information tab. When UAM is successfully connected, icon changes to connected state.
- When the UAM is disconnected, icon changes to disconnected state.

Note

- Do not use the USB hub.
- When UAM is not detected even if it is connected to the PC, click the port refresh button.
- When an additional UAM is connected on the same PC, click the port refresh button.

7.12 Password

Configuration of UAM is password protected for preventing unauthorized access. User should enter the password before proceeding to configuration screen. When the window as shown in the figure 7-37 is displayed, enter the password and click ok. Default password is 12345678.

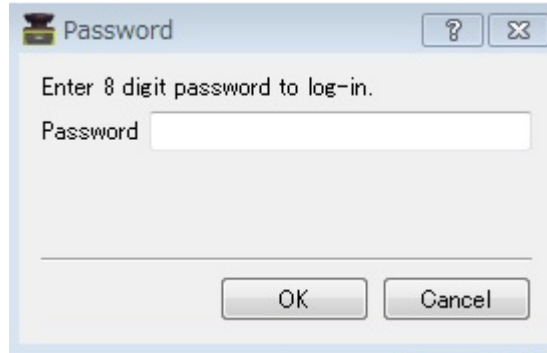

Figure 7-37 Password

7.12.1 Changing the password

User can change the password by performing the following steps:

- Click the Options on the menu bar.
- Click the Change Password.
- Window as shown in figure 7-38 will be displayed.
- Enter the new password and retype the new password for confirmation. The new password should consist of 8 numerical digits.

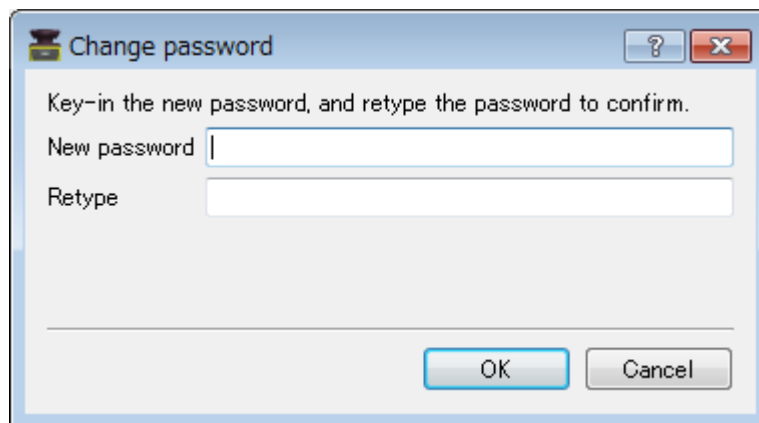

Figure 7-38 Password change

- Click OK to complete the process of changing the password.

7.12.2 Reclaim the forgotten password

When the password is forgotten, follow the steps below to reclaim the password.

- a) Click the File of the menu bar.
- b) Click the Save As or press Ctrl + S and save the project at a preferred location. Project will be saved in the file [*****.huc].
- c) Send this file [*****.huc] file to the nearest office or representative listed on this manual to reclaim the forgotten password.

7.13 Configuration mode

Click on the configuration tab to configure the setting of UAM. The configuration of UAM is password protected to prevent the unauthorized access. User is required to log-in with the password to proceed with the configuration. Refer to chapter 7.12 for details on password. Follow the steps below for configuration.

- a) Confirm that UAM and PC is connected (refer to section 7.11). Connect it if it is not. Even if UAM is not connected, user can configure the settings but cannot the transfer them to UAM.
 - b) Click the “Configuration” tab or on the menu click “Mode” and select “Configuration”
 - c) Enter the product identity and user name in the General configuration tab, Enter the value in the Ethernet information to change the IP setting. This information is also shown on UAM Project Designer’s report.
- Refer to chapter 7.9.3 for details on report display.

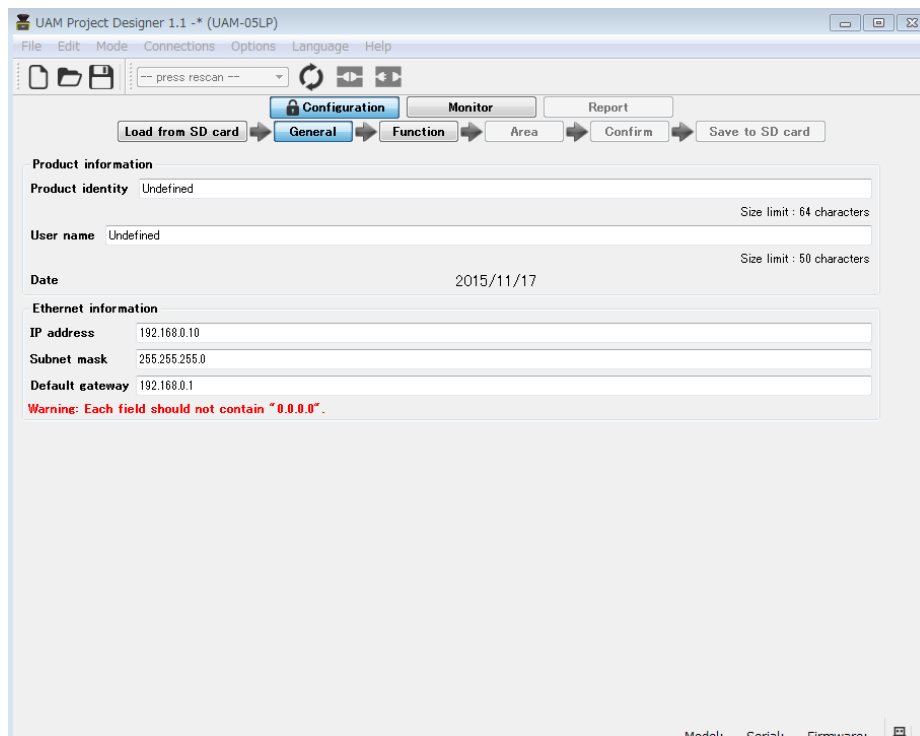

Figure 7-39 General

Note • OSSD remains in OFF state when UAM is in configuration mode

7.14 Function configuration

User can configure various functions of the UAM through UAM project designer. Click on the [Function] tab to display the list of configurable functions (Figure 7-40). Put a check mark to activate the corresponding function (refer to section 7.9.1 for detail). List of configurable functions are shown below. There are some functions which cannot be used simultaneously *¹. In such case, if one function is selected the other will be displayed in gray and cannot be selected. Also, maximum configurable area will change depending on the selected function. Confirm the pin assignment setting as it automatically changes according to the selected function.

- Sensing *²
- EDM
- Interlock
- Reference Monitor
- Muting
- Area Sequence
- Master Slave
- Encoder Input

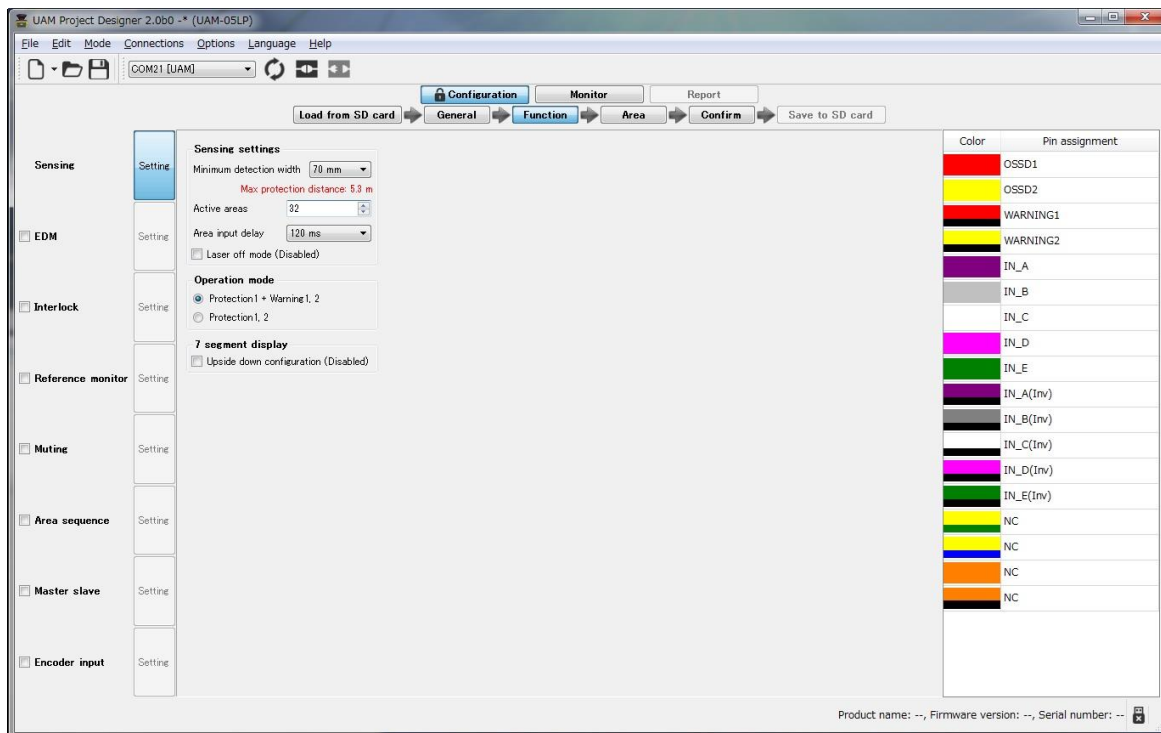

Figure 7-40 Function information

*¹: Muting and encoder, Muting and Interlock, Muting and Master slave functions cannot be configured simultaneously.

*²: Sensing is the basic setting of the sensor therefore there is no check box.

7.15 Area configuration

When Area tab is clicked, area configuration screen will be displayed as shown in figure 7-41.

There exist two types of regions, one where configuration of protection and warning zones are possible and the other where it is not. Range shown in the white represents the region where it is possible to configure the protection zone. Range shown in the light gray is the region where configuration of warning zone is possible. Range shown in the dark gray (beyond 20m from the origin) shows the region where both protection and warning zones cannot be configured. It is possible to configure warning zone inside the protection zone configurable region. Range of protection zone depends on the minimum detection width and changes automatically when it is selected on the sensing setting panel. Configure the number of protection and warning zones activated in the sensing panel.

- Click “Area” button to switch to area configuration panel.

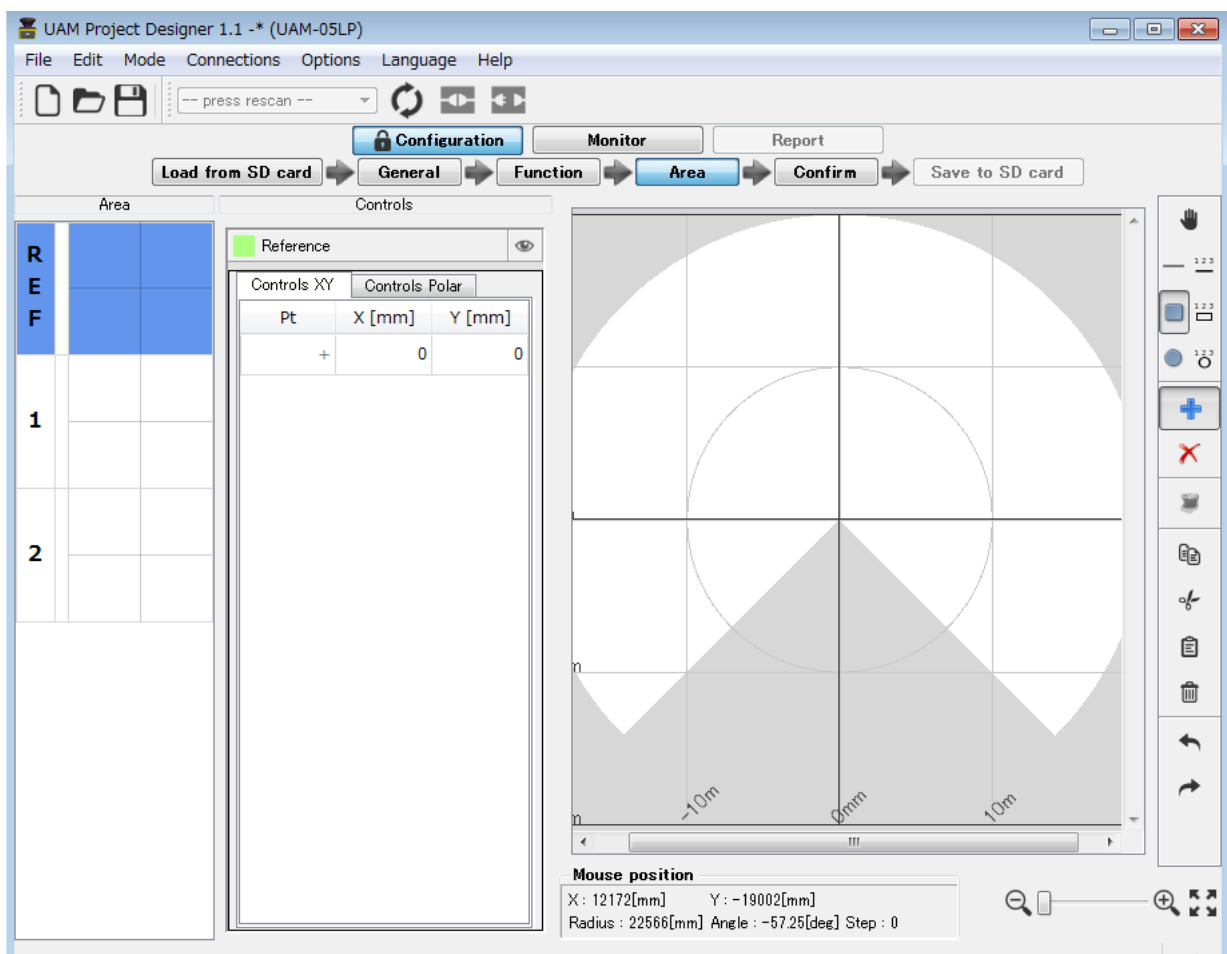



Figure 7-41 Area configuration widow

- Select the area number from area preview panel and click the indented zone among Warning1, Warnign2 and Protection for configuration. Buttons for configuring the Muting and Reference monitoring zone will be displayed when the corresponding functions are enabled. Reference area preview marked by “REF” is visible when reference function is enabled.

7.15.1 Area configuration by drawing tools

Zones can be configured using the drawing tools on the UAM project designer. Refer to Table 7-15 for the details.

- Click on the Add  button.
- Select the drawing shape.
- Move the cursor inside the setting possible region and draw the shape by drag and drop operation.

While drawing it is possible to switch the shapes to draw areas with combination of shapes.

Figure 7-42 (a) shows an example of protection zone set by the selecting the line .

Figure 7-42 (b) shows an example of warning zone1 set by the selecting the circle .

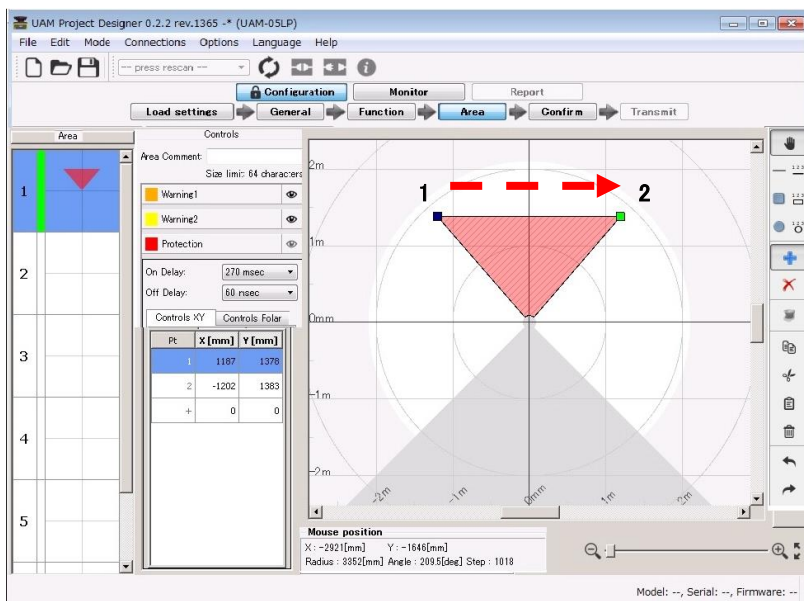

When a straight line is drawn from point 1 → point 2, a triangular shape is formed by connecting these two lines with origin. Coordinates of point 1 and point 2 are also displayed.

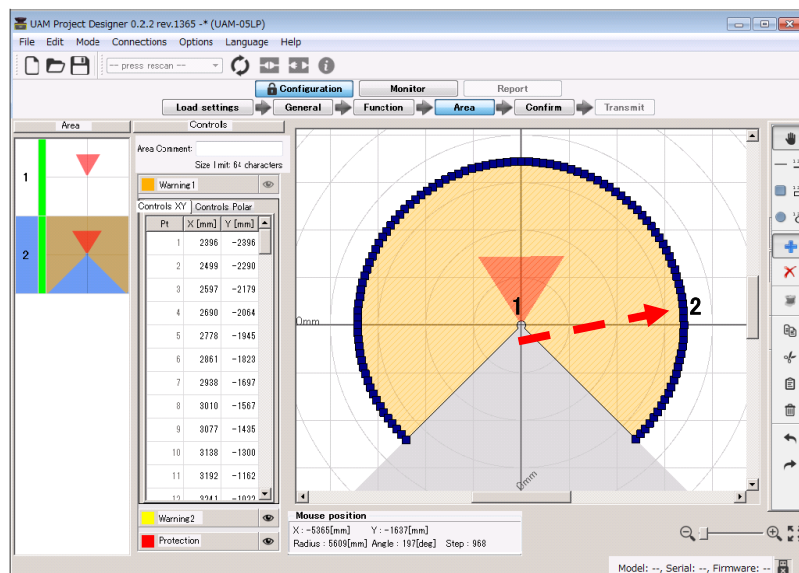

Figure 7-42 (a) Zone configuration example 1



When mouse is dragged from point 1 → point 2, a circular shape with origin at point1 is generated. Circular shape cannot be formed if point is dragged beyond the allowed region. Coordinates of each point are also displayed on the coordinate panel. Points are displayed at every 2.5°.

Figure 7-42 (b) Zone configuration example 2

Coordinates of configured points where the numeric values are shown can be edited directly by double clicking on the cell (Figure 7-43). It is also possible to switch between XY coordinates and polar coordinates. Further, a new point can be added by clicking on the + button on the Pt. column.

* It is possible to copy the 2-column and n-rows data from a text file and paste it in the coordinate table by using   buttons.

* Use backspace key to delete a single coordinate point on the display panel.

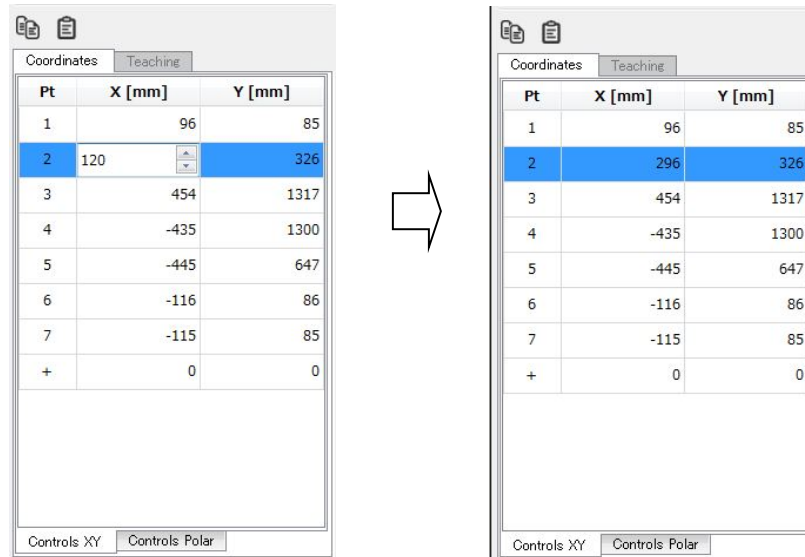



Figure 7-43 Coordinate example

- To delete the parts of the configured zone, click the delete button , then drag-drop the cursor to specify the zone to delete.
- For configuring the other zones, select the respective zone and repeat the above steps.
- Confirm that each zone is configured correctly.

If overlapping of shapes disturbs in creating or confirming the zone, visibility can be toggled by clicking the  button.

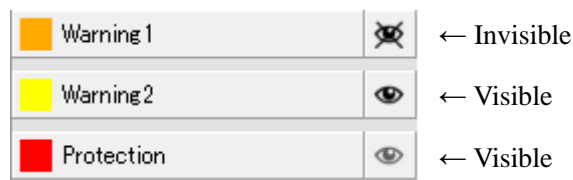



Figure 7-44 Switching between visible and invisible mode

7.15.2 Area configuration by teaching function

Automatic zone configuration by referring the boundary can be done by using the UAM's Teaching function. This function is useful when user needs to configure complex zone or would like to reduce the time for zone configuration. Steps below show the configuration procedures using the teaching function.

- Ensure the UAM is connected with the PC.
- Click on the Teaching  button.
- Enter the offset to be applied between the zone and the background (Max offset can be up to maximum measurement distance).
- Click the "Start" button (Figure 7-45) to start recording the background data. Recording will continue until the stop button is clicked

Further, to use all sensor measurement points for the teaching function, check the [Show all points] and press [Start] button.

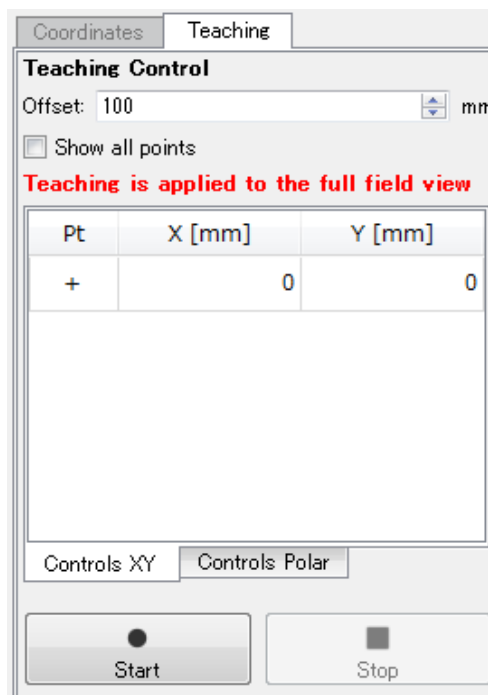

Figure 7-45 Teaching setting

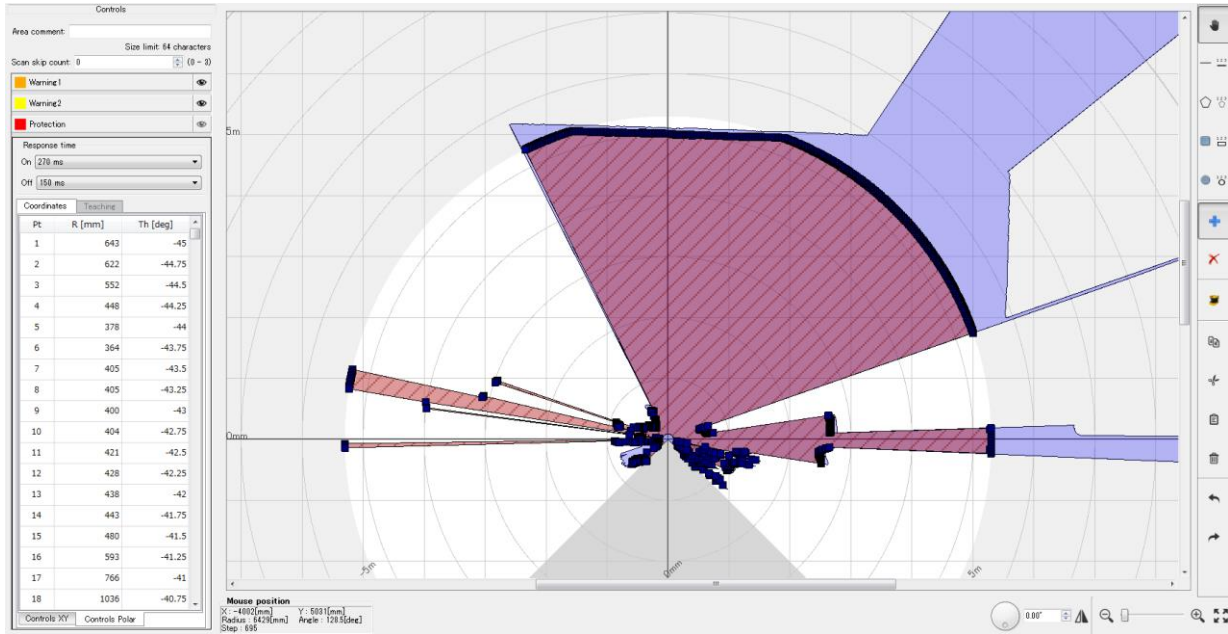

Figure 7-46 Area configured by teaching

- When the stop button is clicked, an area is generated by the smallest data recorded. Configured area will resemble the UAM's background. (Figure 7-46). When configuring the protection zone, if the background is not within the maximum detection distance it is set to maximum detection distance of UAM. In case of warning area, if there is no background within 20m from UAM it will be set to 20m.
- After the area is created automatically it can be edited using the drawing tools.
- It is also possible to specify the region for generating the area by teaching function. Use the area tools for this purpose. If specified region does not have any background, area will be generated at the maximum distance of the specified region.



Danger

- While using the teaching function, user should confirm that the configured zone meets the safety requirement.
- Distance from area to the background should be in the range of 100mm to 700mm.
- If the distance exceeds the above mentioned range, there may be unprotected hazardous area that could lead to critical injury or death.

7.15.3 Muting configuration

Muting function temporarily suspends the safety functions of UAM when required conditions are fulfilled.

Follow the steps below to configure muting function.

- Confirm that muting function is enabled in the function tab.
- Before configuring the muting zone it is necessary to configure the protection zone. Configure the protection zone if it is not yet configured.
- When muting button is clicked, muting configuration screen is displayed. Drag and drop the mouse over the protection zone to configure the muting region inside it. Protection zone is displayed in red and the muting region is displayed in pink.
- Figure 7-47 and 7-48 shows an example of the muting zone configuration. Region in pink represents the muting zone.
- Confirm that the muting configuration is correct.

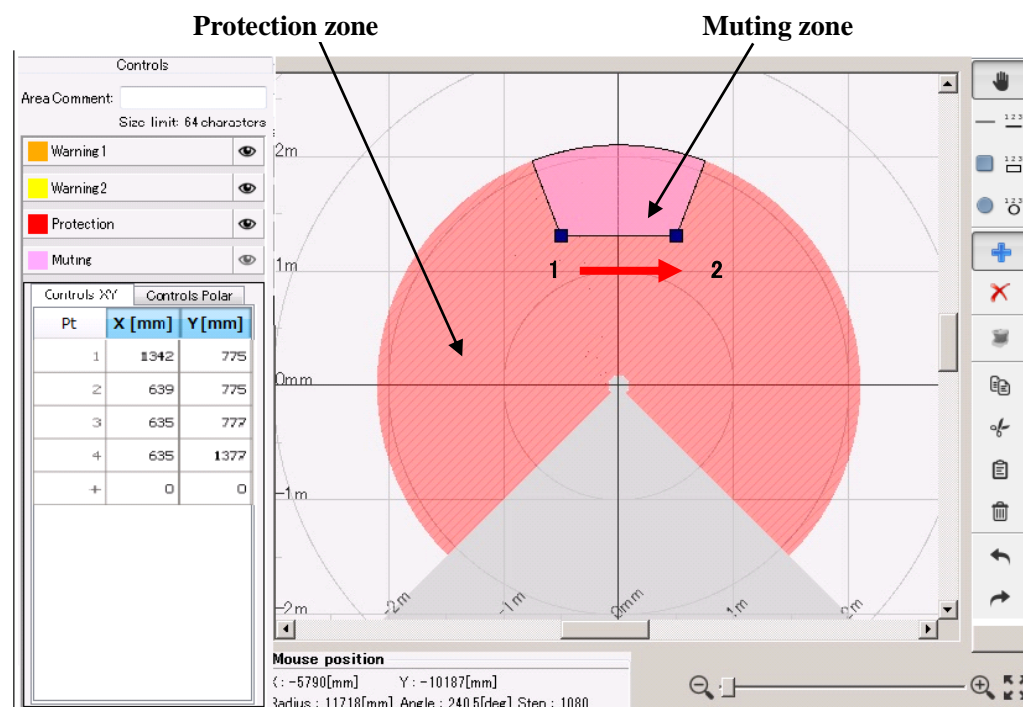

Figure 7-47 Muting zone configuration example 1

Muting zone configuration example as straight line is drawn from point 1 to point 2

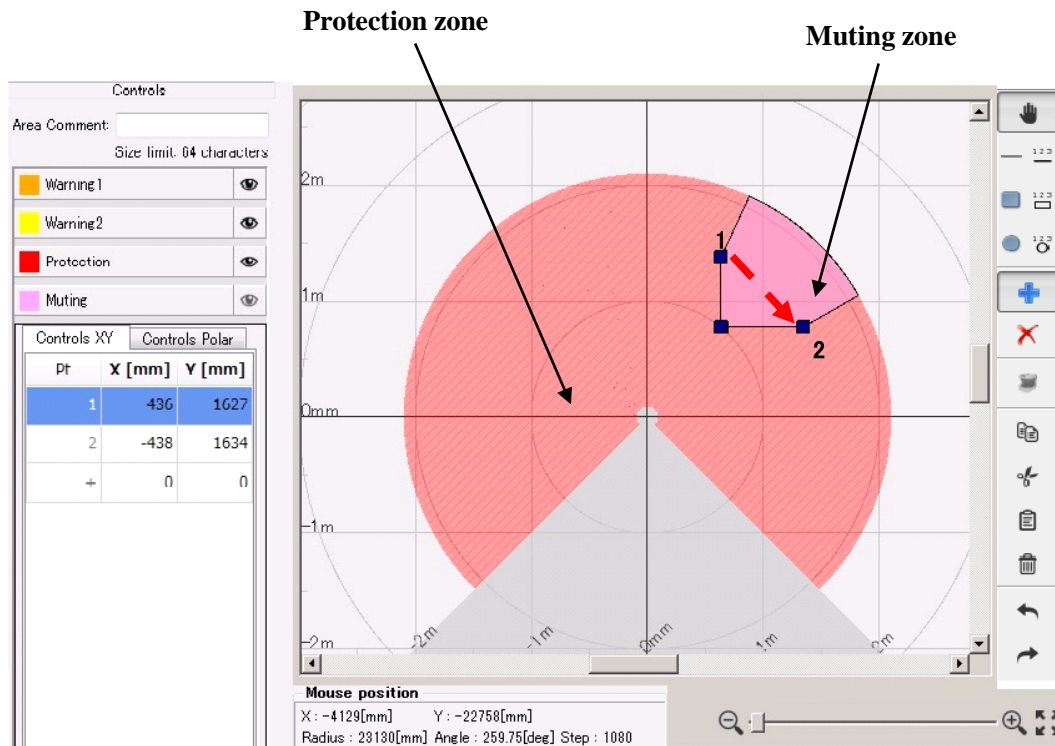

Figure 7-48 Muting zone configuration example 2

Muting zone configuration example as square is drawn from point 1 to point 2

7.15.4 Reference region configuration

Follow the steps below to configure reference region.

- Ensure the UAM is firmly mounted at its location.
- Ensure the connection between the UAM and PC.
- Click the Function tab and enable the Reference Monitor function and enter the required tolerance distance (default 100mm).
- Click the Area tab.
- Main screen displays the configuration for reference region (Figure 7-49). First area on the preview indicated by “REF” represents the reference area.
- Configure the reference region by using the drawing tools. Move the cursor on the drawing panel and drag and drop to configure the reference. Monitoring region is displayed in green

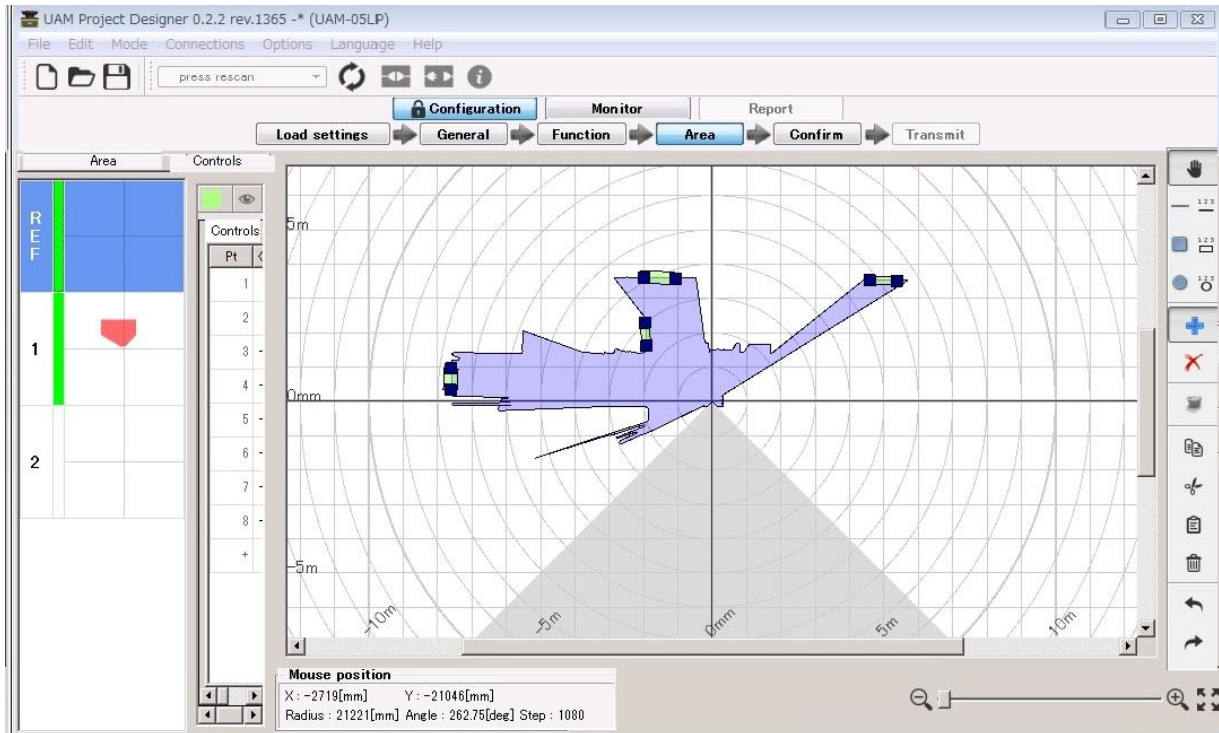

Figure 7-49 Reference region configuration example

For example, to monitor the sensor's displacement by referring the background, choose the line drawing tool and draw a line segment over the background by mouse drag and drop. Reference region with the \pm tolerance is generated on that location (Figure 7-49).

7.16 Transmit configurations to UAM

When all the configurations are complete, click “Confirm” button to verify the configuration. On the confirm screen, check general, function and area settings in order. If any correction is required, return to related tab and reconfigure the setting. On the area confirm screen, click each area preview to confirm all areas.

When confirmation is complete, connect the application with UAM if it is not connected and click “Transmit to sensor” to transmit the configuration. In the disconnected state the configuration can be saved into SD card memory by clicking on the “Save to SD card” button.

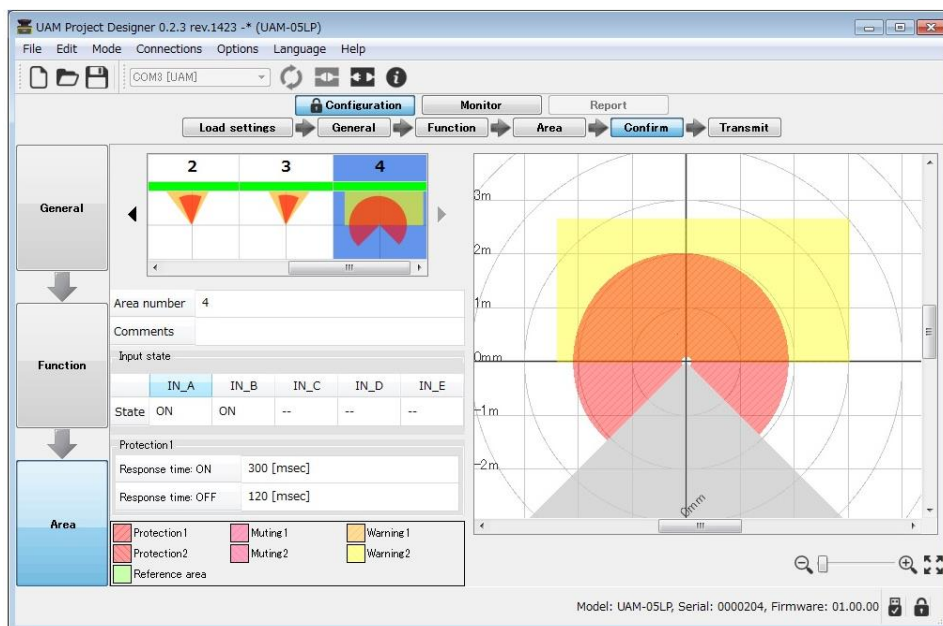

Figure 7-50 Confirm monitor example

When transmit button is clicked verification window appears (Figure 7-51). Click yes to transfer the configuration to UAM

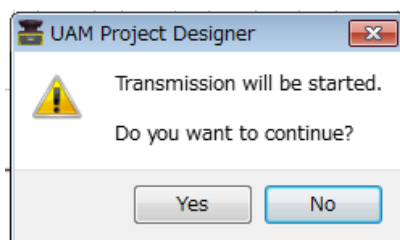

Figure 7-51 Reference monitor configuration example

It may take few minutes to transfer the settings to UAM. When transfer is completed UAM will restart automatically. UAM Project Designer will return to start up panel. Click connect button to run the UAM in monitor mode and verify the operation.

Note • Do not insert SD card while writing the configuration to UAM through USB connection. It may cause configuration failure.

7.17 Save project file

Configured functions and area can be saved into a file as a project. Follow the steps below to save the project file.

- a) Click File from the menu bar.
- b) Click Save As. (Figure 7-52)

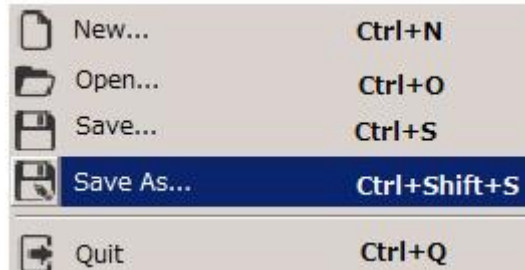

Figure 7-52 Save project file

- c) Enter a file name and click Save button. Change the location of the file if necessary. (Figure 7-53)

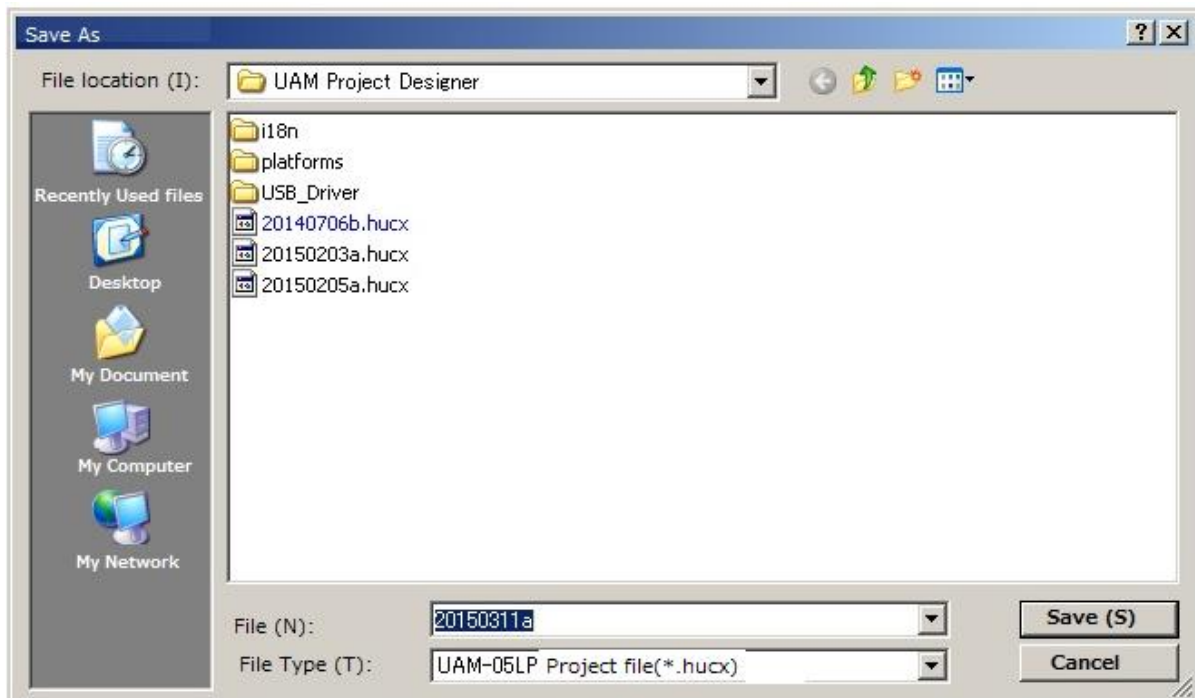

Figure 7-53 Save project file

7.18 Read configuration from UAM

User can check the current settings or confirm the configurations of the UAM by performing the following steps.

- a) Confirm the UAM and UAM Project Designer is connected.
- b) Select Load settings on the sub panel window. Progress panel will appear (Figure 7-54) showing the state. If this button is clicked without connecting the UAM a dialog box will appear to read settings from the SD card (refer to section 7.9.1).

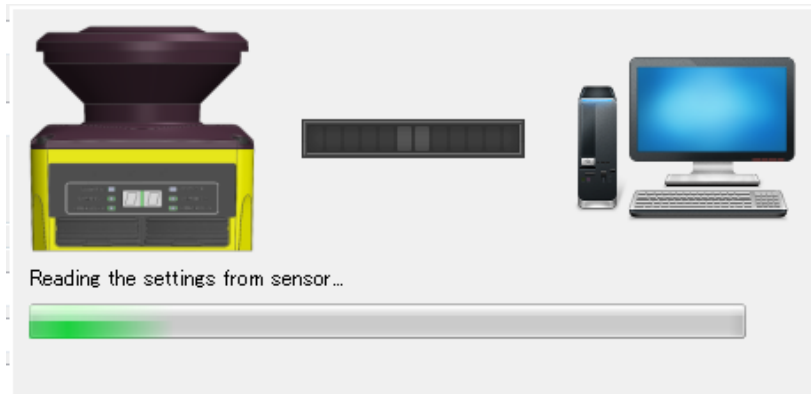

Figure7-54 Reading the configuration of UAM

- c) When reading is complete panel will disappear.
- d) Confirm the General, Function and Area settings. Modify the settings if necessary and click transmit to write the configuration to UAM.

7.19 Open project file

User can open UAM project file by performing the following steps.

- a) Click File from the menu bar.
- b) Click Open
- c) Dialog box will appear (Figure 7-55). Select the project file [*****.hucx] to open.
- d) Application reads the contents of project. Confirm the General, Function and Area settings. Modify the settings if necessary and click transmit button to write the configuration to UAM.

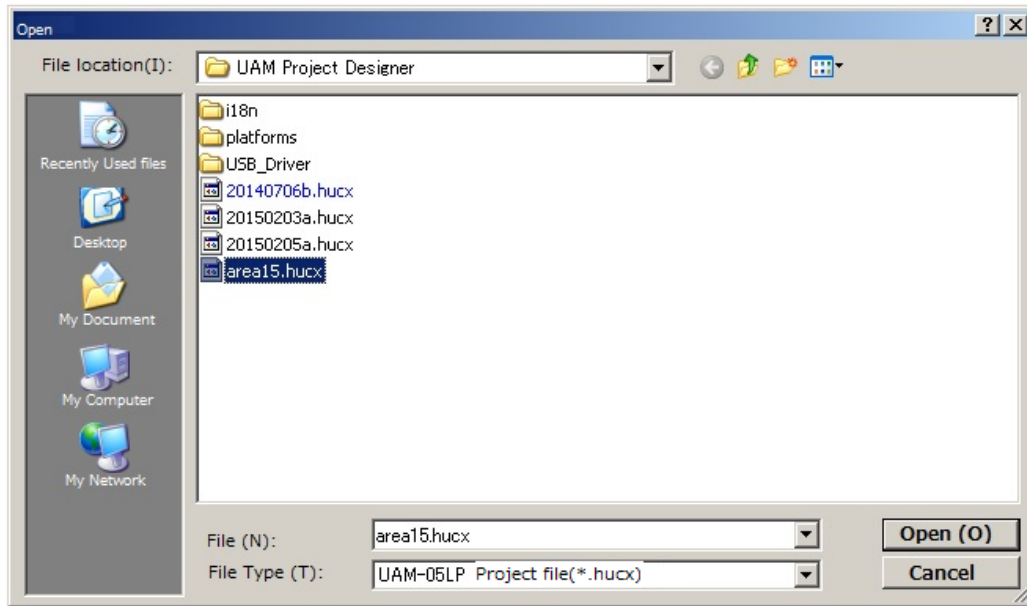

Figure 7-55 Save project file

7.20 Recording the UAM data

Follow the steps below for data recording.

- a) Connect UAM with UAM Project Designer.
- b) Click the monitor button on sub panel. Application will switch to monitor mode.
- c) Click the recorder button.



Figure 7-56 Recorder button

d) Data recording window will appear.

Enter the number of scans in the scan limit field (Figure 7-57) and click the record button. Application will automatically create the file click save. Change the file name and folder if necessary. Data recording will start and stops automatically when the specified scan count is completed. Click the stop button to terminate the recording before reaching the scan count.

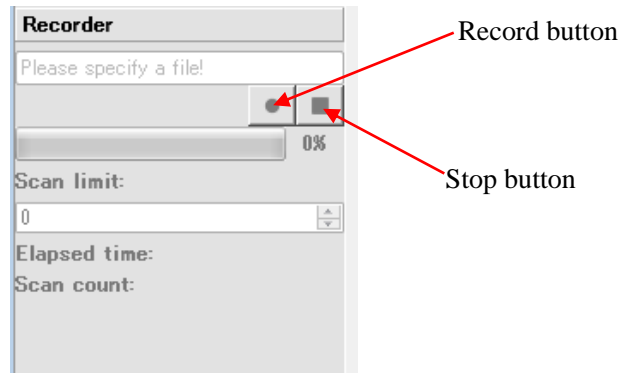

Figure 7-57(a) Data logging window

e) Click "Event Recorder" to record the data just before and after the OSSD signal is triggered to OFF state (Figure 7-57(b)).

Recording duration can be selected from 1 to 15 seconds before and after the OSSD switches to off state. When the data log button is pressed, a window will appear to select the folder for saving the data (create the folder to save the data beforehand). Data logging will begin soon after the folder is selected. Wherever OSSD switches to OFF state, a log data of the specified duration will be saved in the folder. Data logging will continue until the logging stop button is pressed. File name is automatically generated.

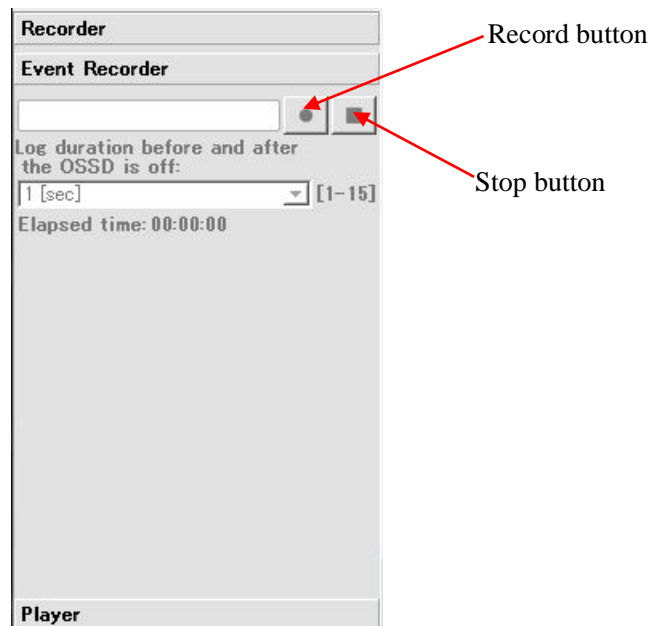

Figure 7-57(b) Event recording window

7.21 Replay the log data

Follow the steps below for re-playing the log data.

- 1 Confirm that UAM is disconnected with UAM Project Designer. Check disconnect button if is connected.
- 2 Click “Monitor” button of sub panel and switch to monitor mode.
- 3 Click player button.

Sensing	
Min detection width	70 [mm]
Active areas	1
Area input delay	120 [ms]
Laser off mode	Disabled
Operation mode	
Protection1 + Warning1, 2	Enabled
Protection1, 2	Disabled
7 segment display	
Upside down configuration	Disabled
Function	
EDM	Disabled
Interlock	Disabled
Reference monitor	Disabled
Muting	Disabled
Area sequence	Disabled
Master slave	Disabled
Encoder input	Disabled
Response time	
Protection1	
On:	270 ms
Off:	120 ms
Recorder	
Player	

Figure 7-58 Log player window 1

- 4 Select the log data file for re-playing (Figure 7-59).

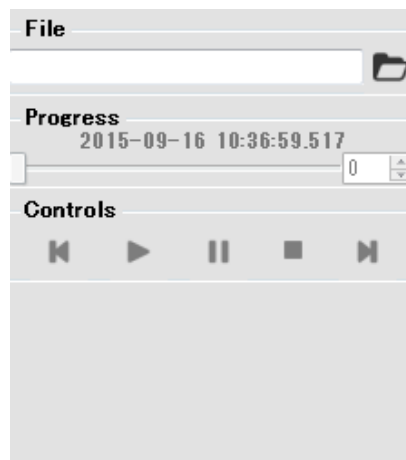









Figure 7-59 Log player window 2

Click the open icon  to choose the file for re-playing and click the play  icon to start viewing the log data. Move the slider bar to the desired position to view the specific scan data.

Control icons are explained in Table 7-20.

Table 7-20 Control button

Icon	Name	Description
	Open	Open and select the log data which you want to play.
	First	Moves to the initial position of log data.
	Play	Starts playing the log data.
	Pause	Pause/ Stops the log data for a while.
	Stop	Stops the log data.
	Last	Moves to the end of log data.

7.22 Save settings to SD card

Configuration data can be saved in the SD card which in turn can be used for directly configuring the UAM without connecting it to the PC.

<Steps to save>

- a) Configure a project in the UAM Project Designer and click confirm button when it is complete.
 - b) In the confirmation tab, check the general, function and area settings in order.
 - c) Disconnect UAM if it is connected with the application
 - d) Click the “Save to SD card” button to switch to the SD card setting tab.
 - e) In the SD card setting tab (Figure 7-60), enter the serial numbers and the 8-digit passwords of all the UAMs intended to be configured with the settings on the SD card. To prevent the change of IP address of the UAM, check the “Exclude IP address setting” on the tab. This will retain the original IP address of all the UAM.
- * It is possible to copy and paste the serial numbers with n-rows and 2 columns from a text file.
- * By default, the first letter of the serial number is assigned as “H”. Enter the correct letter shown on the device if it is other than “H”.
- f) Verify that SD card is inserted into the PC slot and click “Save” button. Save dialog box as shown in Figure 7-61 will appear.
 - g) Select the SD card and click on the “Select Folder” button.

- h) Dialog box as shown in Figure 7-62 will appear. Click OK to complete the save.
- i) Remove the SD card from its slot.

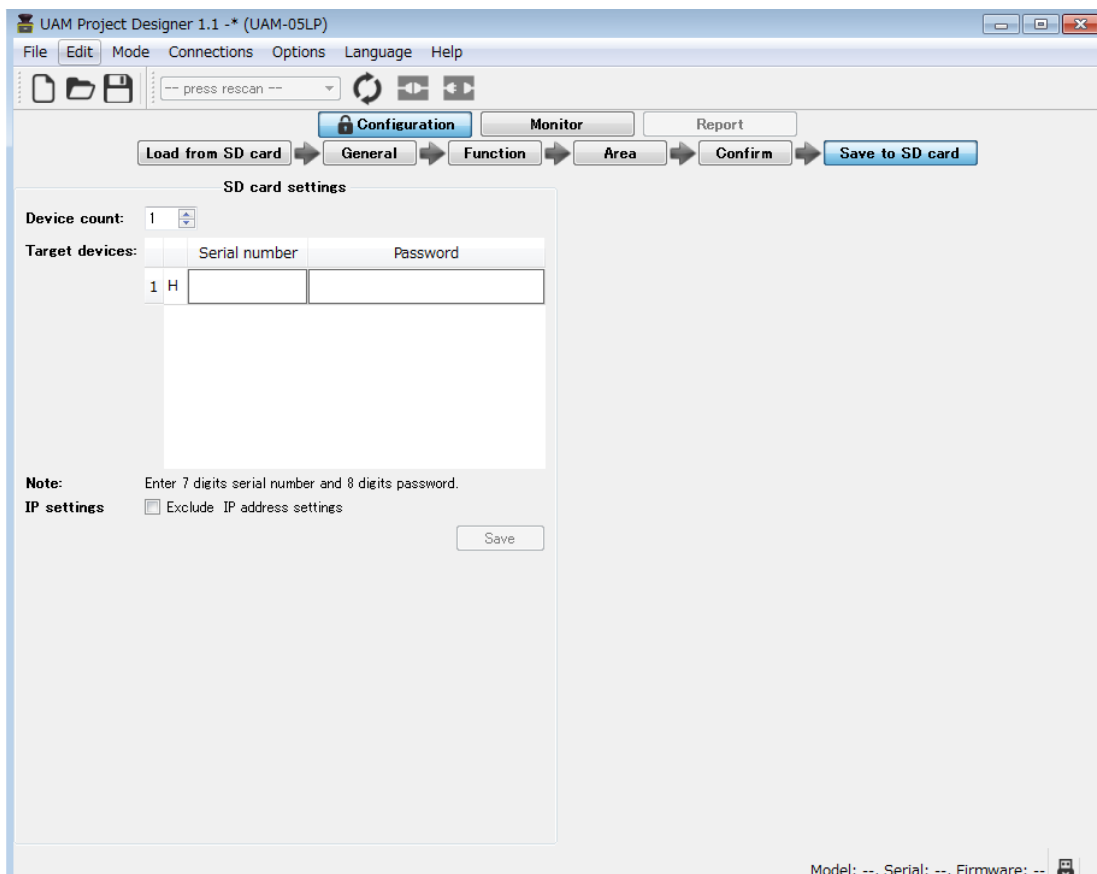

Figure 7-60 SD Card setting screen



Figure 7-61 SD Card selection screen

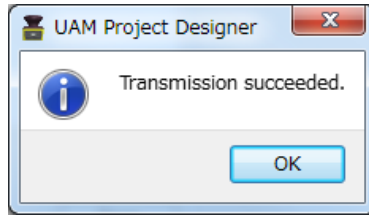

Figure 7-62 Transmission complete window

7.23 UAM configuration through SD card

Configuration from the SD card is possible for the devices whose serial number and password are registered in the SD card. Devices whose serial number or password does not match cannot be configured.

- Enter the SD card containing the setting file into the UAM’s SD card slot. Seven segment display will show the status “F2” to indicate the SD card detection.
- If the serial number and password of the device matches with the registered serial number and password in the file, configuration will start. Seven segment display will show the status “F3”.
- At the end of the configuration seven segment display will show the status “F4”. Remove the SD card from its slot to finish the configuration.
- Seven segment display will show the status “F5” briefly and device will restart showing the status “00”.
- On successful completion area number will be visible on the display.

Note

- Do not switch OFF the UAM or remove the SD card during the configuration. It may lead to configuration failure.
- Do not connect UAM with the UAM Project Designer by USB cable during the configuration from the SD card.
- Do not switch off the UAM without removing the SD card when the display is showing the status “F4”. Configuration will be incomplete in such case.

8. Inspection and maintenance

Inspection and maintenance are necessary for safety operation. User must ensure the inspection and maintenance are carried out as specified in the user’s manual.

Before performing inspection and maintenance, confirm the following items.

- The machine or AGV monitored by UAM is switched OFF.
- The surrounding of working environment is safe.

8.1 Pre-operation inspection

After configuring the UAM the authorized user should perform pre-operation inspection using a test piece. It should be performed without connecting the sensor to the system.

Table 8-1 Pre-operation inspection list example

No.	Check item	Condition	Remark
-----	------------	-----------	--------



		Yes	No	
1	UAM is correctly mounted at the intended location and screws are firmly fastened			
2	All the wirings are correct			
3	The OSSD signal switches from ON state to OFF state when the test piece is placed inside the protection zone			
4	The OSSD signal remains in the OFF state when the test piece is moved inside the protection zone			
5	The OSSD signal switches from OFF state to ON state when the test piece is removed from the protection zone			
6	Area is switched and correctly displayed on UAM when the input signals are changed according to the area switching table			
7	If UAM is in automatic restart mode, OSSD signal switches from ON-state to OFF-state when the test piece is placed inside the protection zone and switches from OFF-state to ON-state when the test piece is removed			
8	If UAM is in manual restart mode, OSSD signal switches from ON-state to OFF-state when the test piece is placed inside the protection zone and remains in OFF-state when the test piece is removed			
9	If the start interlock function is configured, starting the UAM without placing the test piece in protection zone causes the OSSD signal to remain in OFF-state until the RESET signal is provided			
10	If the muting function is configured, UAM terminates the muting (OSSD switches to OFF-state) when the test piece is placed inside the protection zone other than the muting area even though the muting conditions are fulfilled.			
11	If the muting function is configured, UAM does not switch to mute state when the muting input sequence is different than the specified sequence.			
12	If the muting function is configured, UAM does not switch to mute state when the time interval between two muting inputs exceeded the specified time interval			
13	If the muting function is configured, the override function is terminated when the override period exceeds the specified override period			
14	If the reference monitoring function is configured, displacement of the reference boundary structures or UAM should cause the OSSD to switch to OFF-state when displacement exceeds the allowable tolerance. This is applicable especially if the angle of approach exceeds $\pm 30^\circ$ from the detection plane			
15	If the area sequence function is configured, OSSD switches to OFF-state if area switching sequence is different than the configured sequence.			



Note: Stop using the UAM when any check item is marked NO.



Danger

- Do not modify or disassemble UAM during inspection as this will affect its detection capability leading to critical injury or death.

Note

- For the traceability, it is recommended to retain and store the maintenance and inspection records.

8.2 Operation inspection

This test should be performed after completing the pre-operation inspection. It must be performed by taking the sufficient safety measures. Performing this inspection before pre-operation inspection may damage the system leading to critical injury or death.

Table 8-2 Operation inspection list example

No.	Check item	Condition		Remark
		Yes	No	
1	The OSSD signal switches from ON-state to OFF-state and the machine or vehicle stops when the test piece is placed inside the protection zone			
2	The OSSD signal remains in OFF-state and the machine or vehicle stops when the test piece is moved inside the protection zone especially at the border			
3	If the UAM is in manual restart mode, OSSD signal switches from ON-state to OFF-state and the machine or vehicle stops when the test piece is placed inside the protection zone and remains in OFF-state when the test piece is removed			
4	If the UAM is in manual restart mode, OSSD remains in OFF-state when UAM is restarted			
5	If the UAM is in automatic restart mode, OSSD signal switches from ON-state to OFF-state when the test piece is placed inside the protection zone and switches from OFF state to ON state when the test piece is removed			
6	If the UAM is in automatic restart mode, OSSD remains in OFF-state when UAM is restarted with obstacle inside the protection zone			
7	If the start interlock function is configured, starting the UAM without placing the test piece in protection zone causes the OSSD signal to remain in OFF-state until the RESET signal is provided			
8	If the muting function is configured, UAM terminates the muting (OSSD switches to OFF-state) when the test piece is placed inside the protection zone other than the muting area even though the muting conditions are fulfilled.			



9	If the muting function is configured, UAM does not switch to mute state when the muting input sequence is different than the specified sequence.			
10	If the muting function is configured, UAM does not switch to mute state when the time interval between two muting inputs exceeds the specified time interval			
11	If the muting function is configured, the override function is terminated when the override period exceeds the specified override period			
12	If the reference monitoring function is configured, displacement of the reference boundary structures or UAM should cause the OSSD to switch to OFF-state when displacement exceeds the allowable tolerance. This is applicable especially if the angle of approach exceeds $\pm 30^\circ$ from the detection plane			
13	If the area sequence function is configured, OSSD switches to OFF-state if area switching sequence is different than the configured sequence.			

Note: Stop using the UAM when any check item is marked NO.

8.3 Daily inspection

Table 8-3 shows an example of items that should be checked during daily inspection.

Check items and check frequency must be decided by the Person-in-charge after performing the risk assessment.

Table 8-3 Daily inspection list example

No.	Check item	Condition		Remark
		Yes	No	
1	The OSSD signal switches from ON state to OFF state when test piece is placed inside the protection zone			
2	The OSSD signal remains in OFF state when the test piece is moved inside the protection zone			
3	The OSSD signal switches from OFF state to ON state when the test piece is removed from the protection zone			
4	If the UAM is in automatic restart mode, OSSD signal switches from ON-state to OFF-state when the test piece is placed inside the protection zone and switches from OFF-state to ON-state when the test piece is removed			
5	If the UAM is in manual restart mode, OSSD signal switches from ON-state to OFF-state when the test piece is placed inside the protection zone and remains in OFF-state when the test piece is removed			
6	If the start interlock function is configured, starting the UAM without placing the test piece in protection zone causes the OSSD signal to remain in OFF-state until the RESET signal is provided			



7	If the muting function is configured, UAM terminates the muting (OSSD switches to OFF-state) when the test piece is placed inside the protection zone other than the muting area even though the muting conditions are fulfilled.			
8	If the muting function is configured, UAM does not switch to mute state when the muting input sequence is different than the specified sequence.			
9	If the muting function is configured, UAM does not switch to mute state when the time interval between two muting inputs exceeds the specified time interval			
10	If the muting function is configured, the override function is terminated when the override period exceeds the specified override period			
11	If the reference monitoring function is configured, displacement of the reference boundary structures or UAM should cause the OSSD to switch to OFF-state when displacement exceeds the allowable tolerance. This is applicable especially if the angle of approach exceeds $\pm 30^\circ$ from the detection plane			
12	If the muting function is configured, UAM terminates the muting if muting period exceeds the specified maximum period			
13	If the area sequence function is configured, OSSD switches to OFF-state if area switching sequence is different than the configured sequence.			

Note

- Contamination on the optical window switches the OSSD signal to OFF state.

8.4 Periodical inspection

Periodical inspection should be performed to ensure the detection capability of UAM. Table 8-4 below shows an example of periodical inspection items. It is recommended to perform this inspection at every six months interval. This inspection should be performed together with the daily inspection.

Table 8-4 Periodical inspection list example

No.	Check item	Condition		Remark
		Yes	No	
1	Screws are tightly fastened			
2	No displacement from the original mounting position			
3	No scratch or crack on the optical window			
4	Screws of the optical window are tightly fastened			
5	No oil, grease or dirt on the optical window			
6	No visible damage on UAM			
7	Cable connector is in good condition and tightly fastened			
8	Area is switched and correctly displayed on UAM when			



	the input signals are changed according to the area switching table			
9	The OSSD signal switches from ON state to OFF state when the test piece is placed inside the protection zone			
10	The OSSD signal remains in OFF state when the test piece is moved inside the protection zone			
11	The OSSD signal switches from OFF state to ON state when the test piece is removed from the protection zone			
12	If the UAM is in automatic restart mode, OSSD signal switches from ON-state to OFF-state when the test piece is placed inside the protection zone and switches from OFF-state to ON-state when the test piece is removed			
13	If UAM is in manual restart mode, OSSD signal switches from ON-state to OFF-state when the test piece is placed inside the protection zone and remains in OFF-state when the test piece is removed			
14	If the start interlock function is configured, starting the UAM without placing the test piece in protection zone causes the OSSD signal to remain in OFF-state until the RESET signal is provided			
15	If the muting function is configured, UAM terminates the muting (OSSD switches to OFF-state) when the test piece is placed inside the protection zone other than the muting area even though the muting conditions are fulfilled.			
16	If the muting function is configured, UAM does not switch to mute state when the muting input sequence is different than the specified sequence			
17	If the muting function is configured, UAM does not switch to mute state when the time interval between two muting inputs exceeded the specified time interval			
18	If the muting function is configured, the override function is terminated when the override period exceeds the specified override period			
19	If the muting function is configured, the muting is terminated when muting period exceeds the specified maximum muting period			
20	If the reference monitoring function is configured, displacement of the reference boundary structures or UAM should cause the OSSD to switch to OFF-state when displacement exceeds the allowable tolerance. This is applicable especially if the angle of approach exceeds $\pm 30^\circ$ from the detection plane			
21	Safety relay life span is still valid			
22	If the area sequence function is configured, OSSD switches to OFF-state if area switching sequence is different than the configured sequence.			





Caution

- This manual only suggests the basic steps for the inspection and maintenance. User should perform additional inspection and maintenance if necessary.
- User should follow necessary steps in accordance to the working environment.
- Perform all the inspections mentioned in this manual when using the UAM for the first time.

8.5 Cleaning the optical window

Dust covering the optical window could affect the UAM's detection capability. If UAM is installed in a dusty environment, regular cleaning of the optical window is necessary.

Depending on the level of contamination, follow the cleaning method mentioned below.

- Wipe the optical window with a clean soft cloth.
- Clean the optical window with a soft brush.
- Blow off the dust on the optical window using an air-blower.
- Clean the optical window with mild detergent if it is contaminated with oil or grease particles.



Danger

- Disconnect the system when cleaning the optical window.
- Failing to comply with the above could damage the machine, leading to critical injury or death.



Caution

- Do not use organic solvents, such as thinner, benzene, and acetone for cleaning the UAM. Plastic parts and paint might be affected.
- Do not use abrasive cleaner. It might scratch the optical window, resulting in the loss of detection capability.

Note

- Contamination on the optical window switches the OSSD signal to OFF state.

Replacement of the optical window is needed in the following circumstances:

- Crack or scratch on the optical window.
- The surface of the optical window remains contaminated even after cleaning.
- Deterioration of the optical window.

Order the replacement optical window at the nearest distributor or to UAM sales representative.

8.6.1 Method of replacing the optical window

Necessary tools

- Hexagonal wrench
- Torque wrench



- Stop using the system and disconnect the UAM. Remove the UAM from its mounting location.
- Take the UAM to dust free environment. Remove the dust on UAM if it is present. During the replacement of optical window, take sufficient measure to prevent the dust from entering inside the device as this could affect the detection capability of UAM.
- Use wrench to remove screws 1 to 4 fixing the optical window.

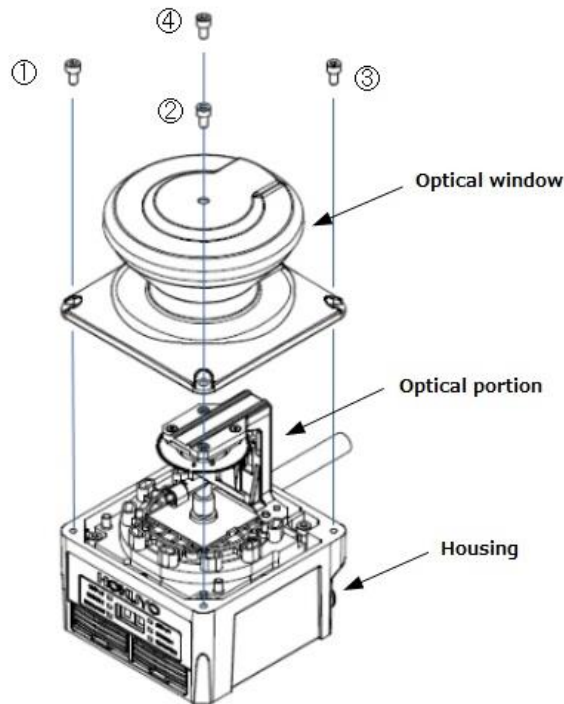
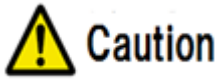

Figure 8-1 Remove the optical window

- To remove the optical window, lift it slowly. Refrain from touching the optical components of UAM. Avoid applying the force while removing as it could damage the optical component affecting the detection capability of UAM.
- If there is contamination around the case, remove it with a clean cloth without touching the optical part.
- If there is contamination on the optical mirror remove it with an air blower.
- Set a torque wrench to 0.63Nm.
- Do not touch the new optical window with bare hands. It is recommended to wear clean thin gloves to unpack the new optical window.
- Check if seal is attached on the surface of the optical window.
- Check the direction to insert the optical window and cover slowly from above. Avoid shaking the optical components.
- Confirm that optical window is correctly attached to the body without any inclination.
- Use torque wrench to tight the 4 screws 1 to 4.

- Confirm that appearance of the UAM is not abnormal before installing it back to original system.
- After installing in the system, adjust the optical window as explained in section 8.6.2.



Caution

- Optical window is a critical part of UAM therefore it should not be contaminated or scratched during the replacement.
- Replace the optical window at clean environment to avoid dust particles from entering the device affecting the detection capability.
- Avoid touching the internal parts of UAM as it may contaminate them decreasing the detection capability.
- After replacing the optical window it is necessary to apply the adjustment UAM is ready to use only after completing the adjustment.
- Use the “Optical Window Adjuster” application to only calibrate a newly replaced optical window. Using it to recalibrate an old optical window may reduce the detection capability of the device.

8.6.2 Adjustment of the optical window

During the operation UAM constantly monitors the transmittance of optical window. When it decreases due to contamination UAM reports an error. Therefore, it is necessary to measure the initial transmittance of the new optical window and save it into the device. Contamination should not be present while performing this adjustment.

<Adjustment steps>

- Use adjustment software “Optical Window Adjuster” included in the CD. Create a local folder and save the application into it. Log file generated during the process (format “serial_number_time.log”) and the adjustment data (format “serial_number_time.csv”) are saved in the same folder where the application is saved. Retain these files for reference and troubleshooting.
- Supply the power to UAM and connect with the PC through USB cable.
- Start Optical Window Adjuster. Window as shown in figure 8-2 will appear.

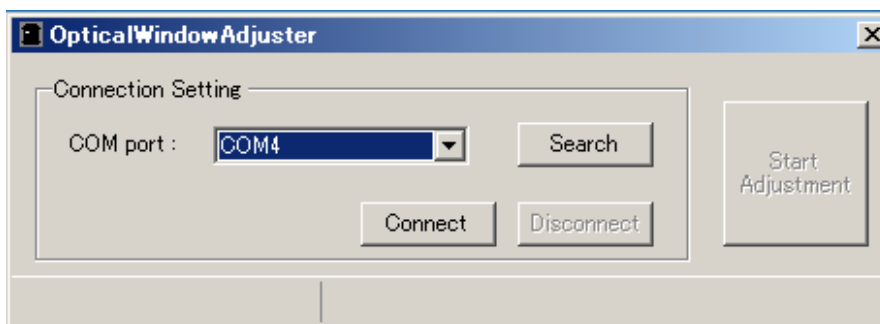

Figure 8-2 Optical Window Adjuster

- Click connect button after UAM is detected and COM port number is displayed. Click search, if COM

port number is not displayed.

e) Click Start Adjustment button when it is enabled.

f) When application is ready, password window will appear. Enter the password of the device and click “OK” button. UAM will restart once and start the calibration. It will take approximately 6 minutes to complete the calibration of 8 contamination channels. 7-segment display on UAM will show the code “CE” during the process.

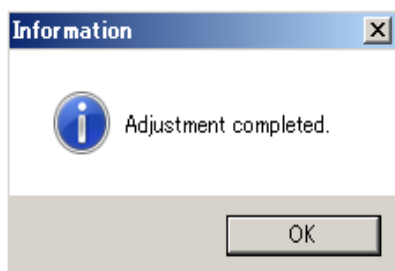

Figure 8-3 Adjustment completed display



Figure 8-4 Error display

g) When adjustment is complete, dialog box as shown in Figure 8-3 will appear. Click the OK button and then click disconnect button (Figure 8-2). Remove the USB cable. UAM will switch to normal operation. Retry the adjustment after checking the optical window and USB connection if an error dialog as shown in Figure 8-4 is displayed. If adjustment fails even after repeated trial contact the nearest distributor or sales representative for support. Send the log file and calibration data file for investigating the cause of failure in such case.

9. Troubleshooting

This chapter describes troubleshooting methods while operating the UAM. Table 9-1 below shows the troubleshooting list.

Table 9-1 Troubleshooting list

Situation	Possible reason	Solution suggestion
UAM is not operating	Power supply is OFF /Over voltage/ Under voltage	Make sure power supply is ON
		Check the supplied voltage.
		Check the condition of the power supply cable.
	Cable is damaged	Replace with a new cable
	Configuration is incomplete	Reconfigure UAM
UAM can not connect with the UAM Project Designer	PC trouble	Check the PC's specification. Make sure the specification is compatible.
		Close the other unrelated applications and reconnect
	Power supply is OFF	Make sure the power supply is ON
		Check the supplied voltage.
		Check the condition of the power supply cable.
USB cable is not connected to USB port	Make sure the USB is connected to both PC and UAM	
Measurement data is not displayed	Power supply is OFF	Make sure the power supply is ON
	UAM is in error/lockout state	Check the supplied voltage.
		Check the condition of the power supply cable.
		Check the error number in the 7-segment table Restart UAM if it is blinking
OSSD remains OFF even though the protection zone is free from obstacle	Light interference	Mount UAM at a location free from light interference Refer to chapter 5.1 for light interference counter measures
	Mutual interference	Refer to chapter 5.2 for mutual interference counter measures
	Contaminated optical window	Check for any contamination or damage on the optical window
	Floor is detected	Change the mounting position such that the floor is not detected. Reconfigure the detection area.
	Background is detected	Reconfigure the detection area such that background is not detected.
	Lockout state due to self-diagnostic function	Check the description of the error number and perform the possible solution as suggested

UAM is interlocked	Check the configuration of the interlock function. If RES_REQ is ON, supply UAM with RESET signal
--------------------	---

Table 9-2 shows the error number of the UAM. These numbers are displayed on the 7-segment display of UAM. If UAM is unable to resume the normal operation, contact the nearest distributor or sales representative (included in last page of the manual) for support.







Table 9-2 Error number list

Error number	Details	Possible reason	Solution suggestion
45	Setting error/Incomplete setting	Reconfigure UAM	Automatic recovery or Input reset (During Interlock setting)
56	Invalid area error	Confirm the input status during area switching.	Automatic recovery or Input reset (During Interlock setting)
57	Area input connection error	Confirm the input status during area switching.	Automatic recovery or Input reset (During Interlock setting)
59	Area sequence error	Confirm area switching sequence.	Automatic recovery or Input reset (During Interlock setting)
5B	Encoder speed error	Make sure the encoder speed is correctly configured	Automatic recovery or Input reset (During Interlock setting)
5C	Encoder error	Confirm the encoder input status.	Automatic recovery or Input reset (During Interlock setting)
5D	Encoder speed error	Make sure the encoder speed is correctly configured	Restart the power supply
5E	Invalid area error (During Encoder is valid)	Confirm the input status during area switching.	Automatic recovery or Input reset (During Interlock setting)
5F	Encoder speed error	Make sure the encoder speed is correctly configured	Automatic recovery or Input reset (During Interlock setting)
60-63	Motor error	Mount the sensor in a way that the vibration, bump stated in the specification does not exceed.	Automatic recovery or Input reset (During Interlock setting)
64	Master-Slave communication error	Confirm the connection between master and slave.	Automatic recovery or Input reset (During Interlock setting)
70	Optical interference/High reflective background	Mount UAM at a location free from light interference. Refer to chapter 5.1 for light interference counter measures.	Automatic recovery or Input reset (During Interlock setting)



72	Operating temperature error	Make sure that operating temperature is within specification.	Restart the power supply
74-79	Power supply error	Make sure that voltage is within the specification.	Restart the power supply
7C	OSSD excess current error	Make sure the OSSD load is within the specification.	Restart the power supply
7D	Slave unit 1 error	Check the error code on slave unit 1	Automatic recovery or Input reset (During Interlock setting)
7E	Slave unit 2 error	Check the error code on slave unit 2	Automatic recovery or Input reset (During Interlock setting)
7F	Slave unit 3 error	Check the error code on slave unit 3	Automatic recovery or Input reset (During Interlock setting)
80	Master unit error	Check the error code on master unit	Automatic recovery or Input reset (During Interlock setting)
84,85	Object in limited detection zone or contamination on the optical window.	Clean the optical window (refer to chapter 8.5 for cleaning the optical window). Further, remove any objects present inside the zone with limited detection capability (refer to chapter 5.4) of UAM.	Automatic recovery or Input reset (During Interlock setting)
86	Mutual interference error	Mount UAM at a location free from mutual interference. Refer to chapter 5.2 mutual interference for counter measures.	Automatic recovery or Input reset (During Interlock setting)
8F	SD card detection error	Check SD card file or check the specification of the SD card.	Restart the power supply
95-9A, A8, AC	OSSD diagnostic error	Check the OSSD connection.	Restart the power supply
A6	EDM1 input connection error	Check the EDM1 connection.	Restart the power supply
A7	EDM2 input connection error	Check the EDM 2 connection.	Restart the power supply
A9	Reset input error	Check the RESET connection.	Restart the power supply
AA	Reference monitor error	Check for the displacement of reference structure or UAM position	Automatic recovery or Input reset (During Interlock setting)
B1,B9	Optical window is contaminated 	Refer to chapter 8.5 for cleaning the optical window	Automatic recovery or Input reset (During Interlock setting)



B2, BA	Optical window is contaminated 		
B3, BB	Optical window is contaminated 		
B4, BC	Optical window is contaminated 		
B5, BD	Optical window is contaminated 		
B6, BE	Optical window is contaminated 		
B7, BF	Optical window is contaminated 		
B8, C0	Optical window is contaminated 		
C1	Optical window is removed or contaminated	Replace or clean the optical window	Restart the power supply
CE	Adjustment of the optical window is incomplete after replacement. (Displays CE during the adjustment of the optical window.)	Adjust the optical window	Automatic recovery or Input reset (During Interlock setting)
CF	UAM is not configured	Configure UAM	Automatic recovery or Input reset (During Interlock setting)
D3-E6	Configuration is incomplete	Reconfigure UAM	Restart the power supply
F0	SD card initialization error	Remove the card and try again	Automatic recovery or Input



			reset (During Interlock setting)
F1	SD card file content error	Check the setting file in the SD card	Automatic recovery or Input reset (During Interlock setting)
Other Error (41-F5)	Device Error	<p>Make sure that FG wire is correctly to the ground.</p> <p>Also check the surrounding disturbance of the operating environment.</p> <p>Mount the sensor within the stated vibration, bump in the specification.</p> <p>Replace UAM if it does not recover even after restoring the power supply.</p> <p>Contact the nearest distributor or sales representative for the repair.</p>	Restart the power supply

* In 7 segment display B and D will display as b and d.

* Error numbers are represented by: 0, 1, 2, 3, 4, 5, 6, 7, 8, 9, A, B, C, D, E, and F.

Note

- When adjusting the optical window using “Optical Window Adjuster”, code CE will be displayed on the 7-segment of UAM. On successful completion of the adjustment, UAM will resume to normal operation displaying the area number.



10. Specification

10.1 UAM-05LP

Table 10-1 UAM-05LP specification

Subject		Specifications	
Model		UAM-05LP-T301	UAM-05LP-T301C
Detection property	Protection Range	Max: 5m	
	Warning Range	Max: 20m (Non-safety) *1	
	Distance tolerance*2	+100 mm	
	Detection capability	From Black-Reflector Sheet (1.8%) to Retro-Reflector Sheet	
	Angular Range	270 °	
	Minimum Detectable Width	φ30 mm (Max: 1.8m) φ40 mm (Max: 2.5m) φ50 mm (Max: 3.0 m) φ70 mm/φ150 mm (Max: 5.0 m)	
	Scan Frequency	30ms (Rotational Speed: 2000 rpm)	
	Area pattern	Max 32 patterns (128 when encoder input function is used)	
	Response time	OFF	60 ms~2010 ms
	ON	270 ms~2010 ms	
Optics	Element	Pulsed Laser Diode	
	Wave Length	905 nm	
	Safety Class	Laser Class 1	
Type		Type 3 (IEC61496-1, IEC61496-3)	
Functional Safety		SIL 2 (Type B, HFT=1) (IEC61508)	
PFH _d		7.8×10 ⁻⁸ (T1=20 year) : When master slave function is not in use. 1.6×10 ⁻⁷ (T1=20 year) : When master slave function is in use.	
Housing	Size	80mm (W)×80mm (D)×95mm (H) (without cable)	
	Weight	0.8Kg	0.5Kg
	Protection	IP65	
	Case Material	Body: Aluminum Optical Window: Polycarbonate	
	Connection Cable	Flying lead cable length: 3m	Waterproof connector: 0.3m
Power supply		DC 24V ±10%: when operation using converter power supply DC 24V -30%/+20%: when operation using battery	
Supply current	Normal (without load)	6W	
	Max. (with load)	50W	
Startup time		Less than 30s	

*1. Distance when reflectance of the object is 90% or above.

*2. Additional distance of 200mm is needed when the UAM is working under high reflective background.

Subject		Specifications
Output	OSSD 1/2 (Safety)	Output type (High side SW)
		Output current:(Max:500mA) *3
		Leak current (Max:1mA)
		AWG 26
		Load tolerance (L/R=25ms, C=1μF)
	OSSD3/4 (Safety)/ WARNING 1/ 2 (Non-Safety)	Output type (High side SW)
		Output current:(Max:250mA) *3
		Leak current (Max:1mA)
		AWG 28
		Load tolerance (L/R=25ms, C=1μF)
	RES_REQ 1, RES_REQ 2, MUT_OUT 1, MUT_OUT 2	Output types (PNP Transistor)
		Output current (Max: 200mA)
Leak current (Max: 1mA)		
AWG 28		
Input	Area pattern 32 (5 Inputs x 2 Channels) EDM1, EDM2, MUTING1, MUTING2, MUTING3, MUTING4, OVERRIDE1, OVERRIDE2, RESET1, RESET2	Input Impedance 4.7 kΩ AWG 28
	ENC_A1, ENC_A2, ENC_B1, ENC_B2	Input Impedance 4.7 kΩ AWG 28
Interface	Configuration	USB2.0 (USB micro type-B connector)
		RS-485
		Ethernet 100BASE-TX (Water proof connector)
Communication Data	Measurement Error (Distance) *5	±35mm (TYP)
	Max Range (Distance)	40m
Angular Error	Vertical Plane *5	±1° (Beam divergence is excluded)
	Horizontal Plane *5	±0.3° (Beam divergence is excluded)
Environmental resistance	Temperature	-10°C to +50°C (No freezing)
	Storage Temperature	-25°C to +70°C (No freezing)
	Humidity	95% RH with no condensation
	Storage Humidity	95% RH with no condensation
	Surrounding Intensity*4	Less than 1500 lx



Vibration	Frequency range: 10~55 Hz Sweep rate: 1 octave/min Amplitude: 0.35 mm \pm 0.05 mm
Bump	Acceleration: 98m/s ² (10G) Pulse hold duration: 16 ms
Outdoor Operation	Not permitted
Altitude	Below 2000m

*3. Total current supply of OSSD output and Warning output should be below 1.0A.

*4. When the light sources are located at $\geq 5^\circ$ from the detection plane of UAM.

*5: Reference data measured at the manufacturer's facility.

Scan Angle Error (Reference data)

Horizontal and vertical angular error of the optics with reference to the UAM's mechanical axes are $\pm 0.3^\circ$ and $\pm 1^\circ$ respectively (figure below). Mount the device appropriately if it is necessary to strictly limit the detection range.

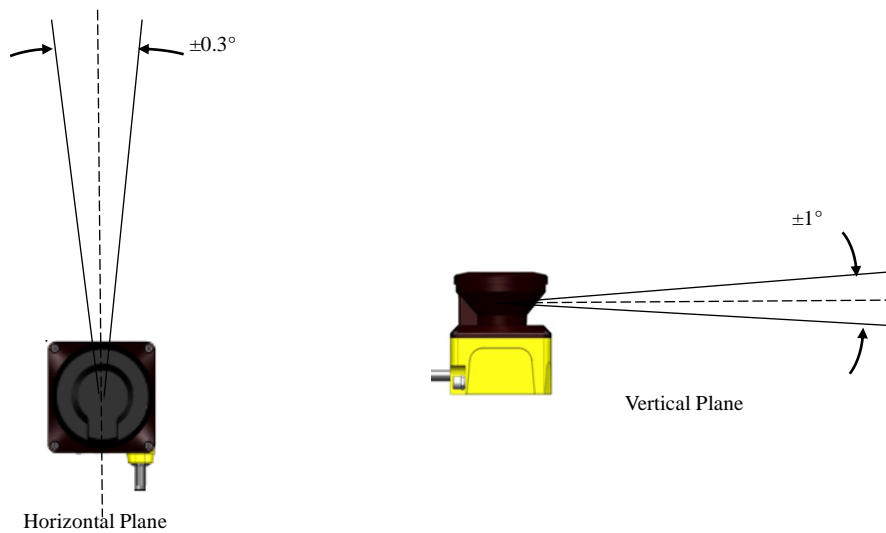

11. Package contents

The following items are included in the package.

- a) UAM ×1



- b) Quick Reference ×1



- c) Configuration CD ×1



12. Options

12.1 Base mounting bracket (Model: UAM-BK03)

This base bracket can be used to change the horizontal alignment of the UAM during installation. This bracket is useful especially in preventing the mutual interference when two or more UAMs are used. (Refer to external dimension)

12.2 Rear mounting bracket (Model: UAM-BK04)

This rear bracket can be used to change the vertical and horizontal alignment of the UAM during installation. This bracket is useful especially in preventing the mutual interference when two or more UAMs are used. (Refer to external dimension)

12.3 USB cable (Model: UAM-MUSB)

This cable is used to connect the UAM and PC. Length of the USB cable is 1m. This cable is used during the configuration of the UAM.



12.4 Ethernet cable (Model: UAM-ENET)

This cable is used for connecting the UAM and PC for the measurement data output. Cable Length is 3m.

12.5 Configuration CD (Model: UAM-CD03)

This CD contains the configuration software, UAM Project Designer, USB driver and other related documents.



12.6 Optical window for replacement (Model: UAM-W002)

Replacement part when optical window is scratched or damaged.



12.7 Cover Bracket (Type: UAM-BK05)

Cover brackets for optical window protection that can be used in combination with mounting brackets. (See the dimension)

12.8 Connector Cable (UAM-05LP-T301C Only)

Model	Cable Length (m)
UAM-5C02C	2
UAM-5C05C	5
UAM-5C10C	10
UAM-5C20C	20

13. External dimension

13.1 UAM-05LP

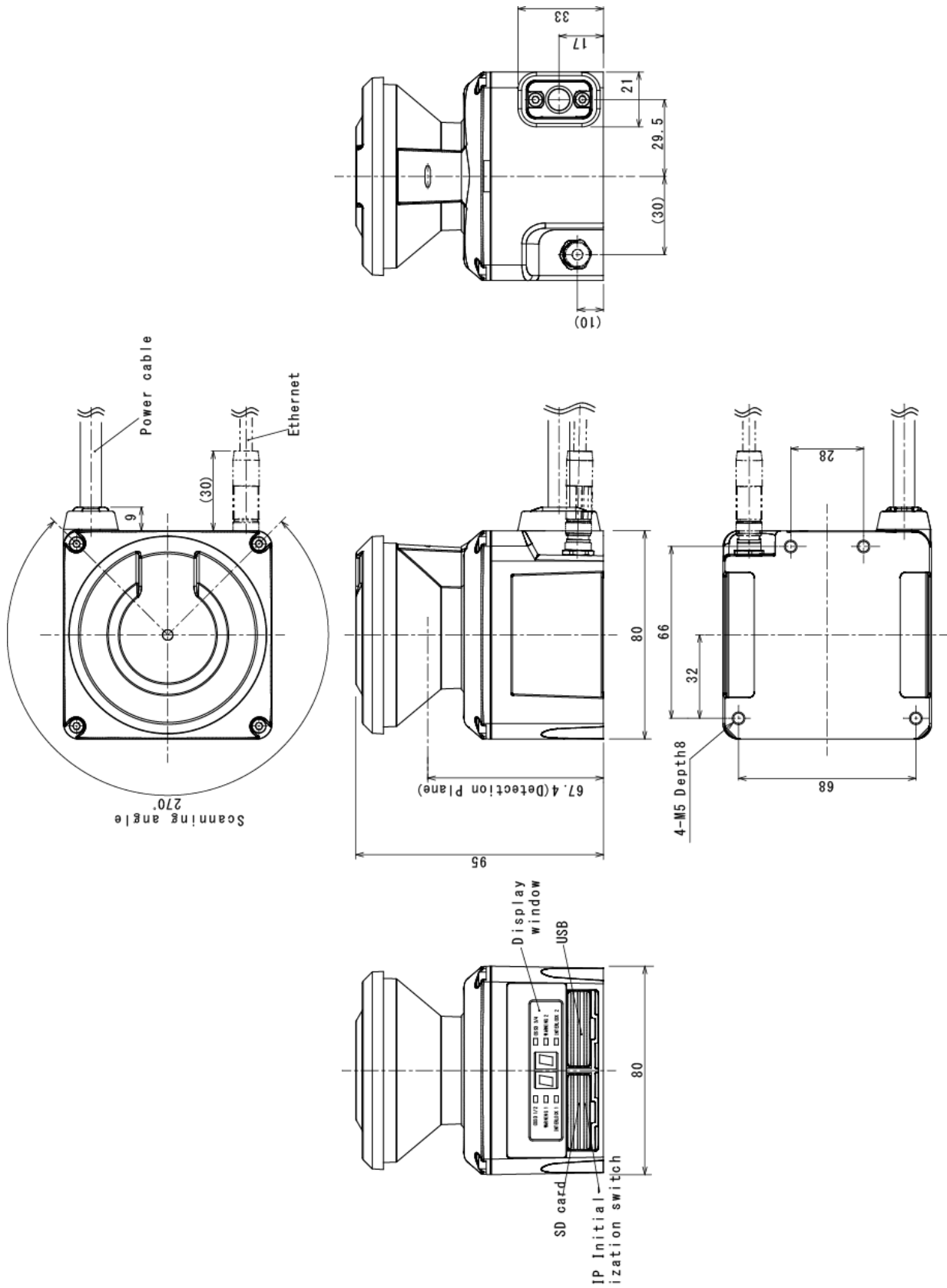

13.2 Base mounting bracket

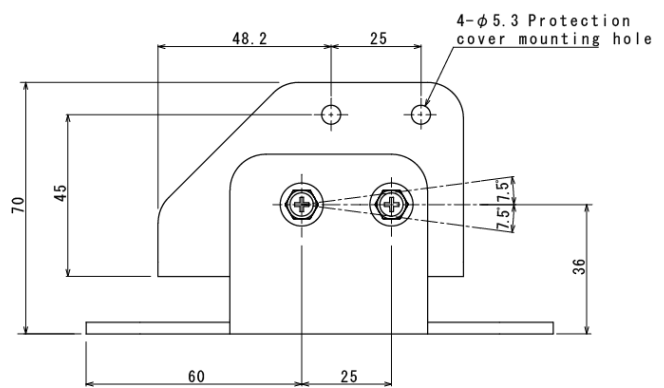
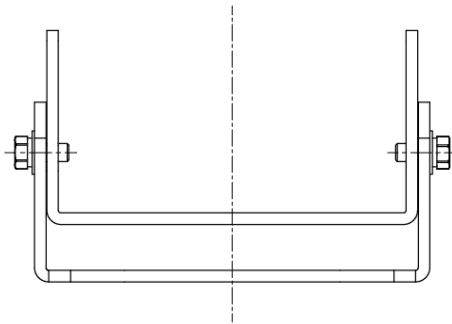
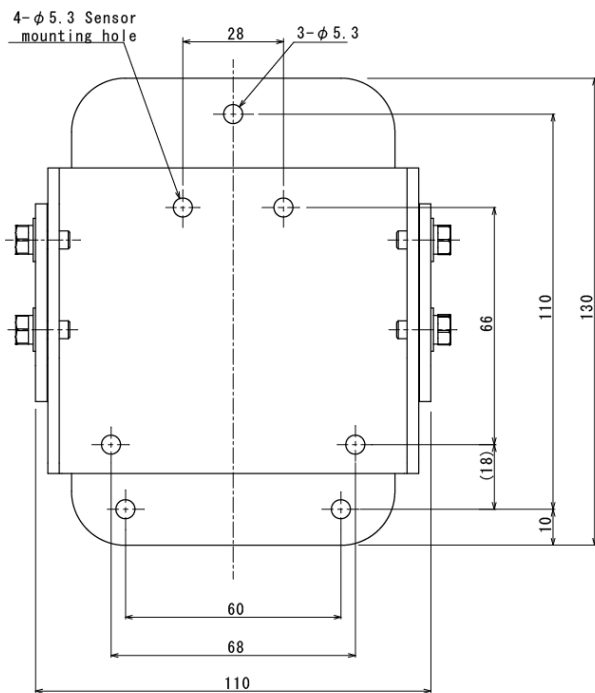

13.3 Rear mounting bracket

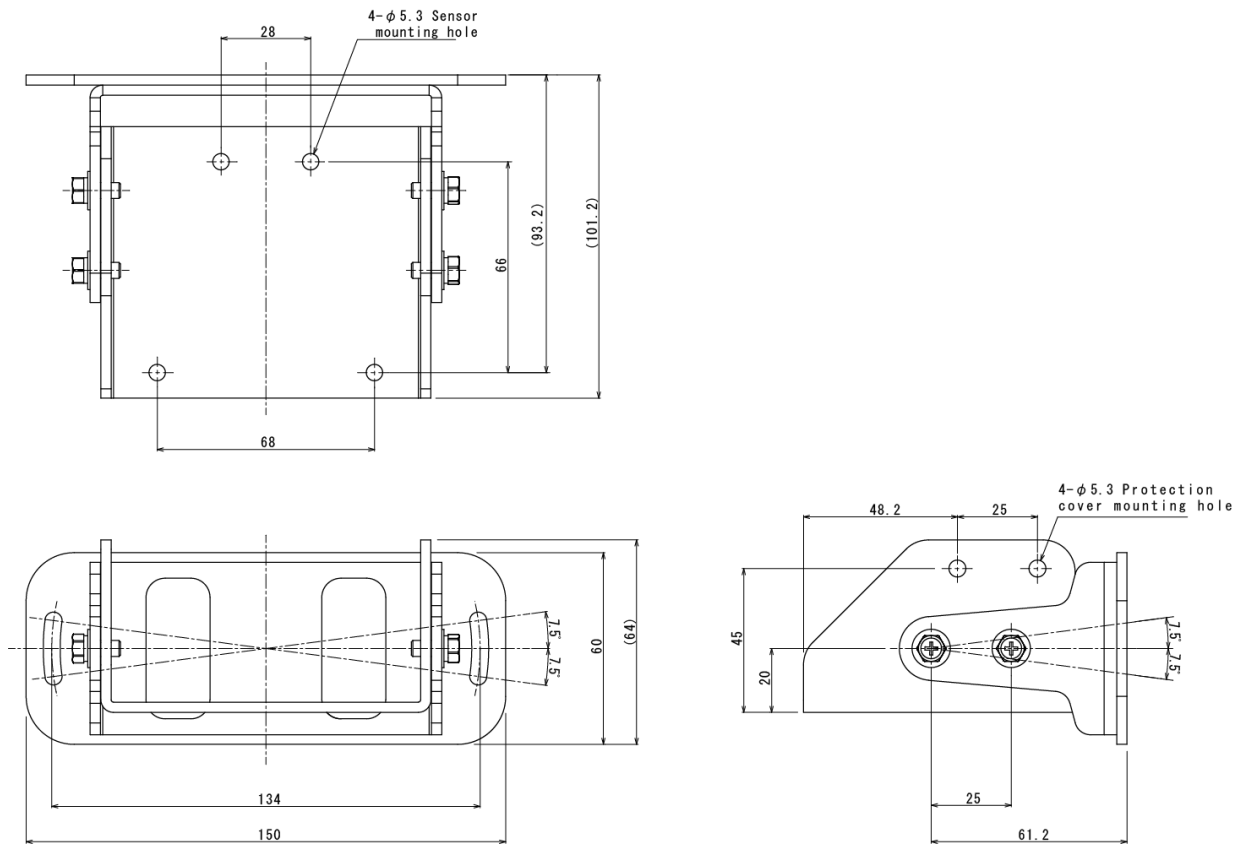

13.4 Cover Protection Bracket

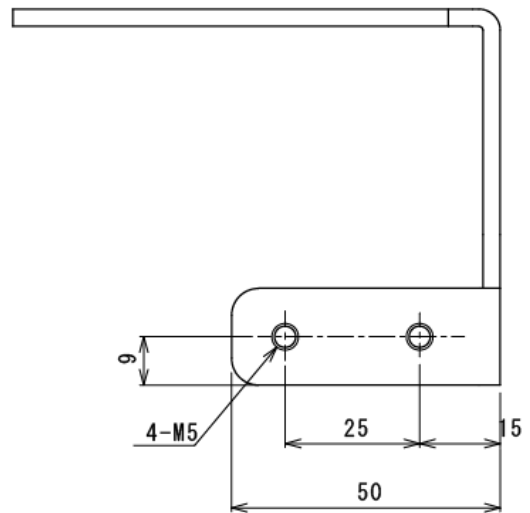
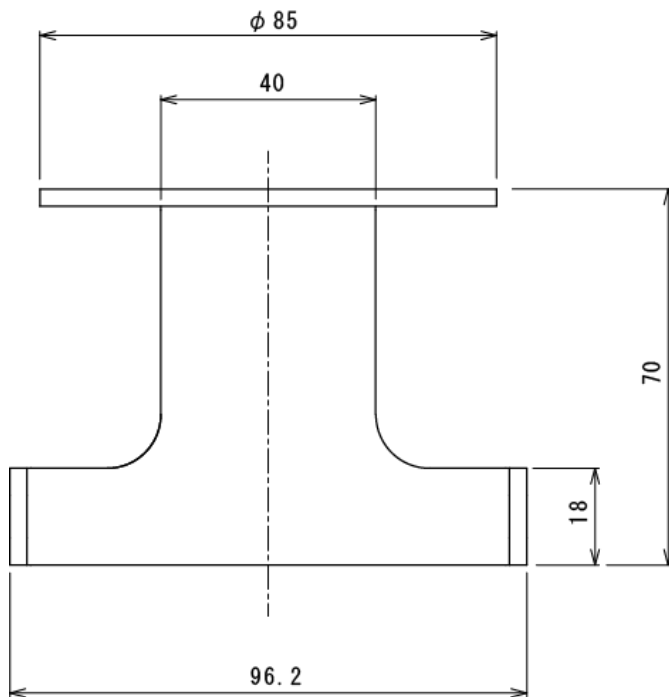
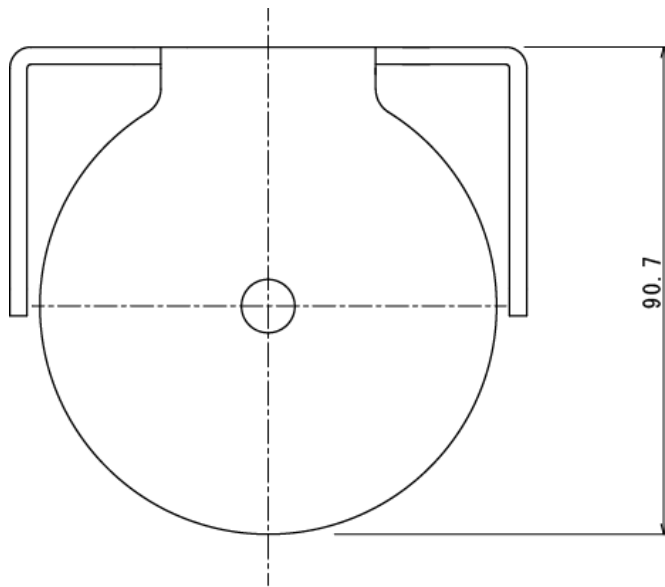

14. EC Declaration of conformity



EC DECLARATION OF CONFORMITY

We, the undersigned,

Manufacturer : HOKUYO AUTOMATIC CO., LTD

Address, City : Higobashi Union Building, 1 - 9 - 6 Edobori, Nishi - ku, Osaka 550 - 0002

Country : Japan

Authorized representative in Europe

: Hongwei Liu, Hokuyo Automatic Co.,Ltd. Amsterdam Branch

Address City : Prof.J.H. Bavincklaan 2, 1183 AT Amstelveen

Country : The Netherlands

Certify and declare under our solo responsibility that the following apparatus

Description : Safety Laser Scanner

Manufacturer : HOKUYO AUTOMATIC CO., LTD

Identification : UAM - 05 Series

confirms with the essential requirements of the EMC Directive 2014/30/EU, based on the following specifications applied

- EU Harmonized Standards
- EN55011 : 2009 + A1 : 2010 Group1 ClassA
- EN61000 - 6 - 4 : 2007 + A1 : 2011
- EN61496 - 1 : 2013 (Type3 ESPE)
- EN61000 - 6 - 2 : 2005
- EN62061 : 2005 + A2 : 2015
(Regarding EMC requirement : refer to EN61326 - 3 - 1 : 2008 SIL2)
- IEC61326 - 3 - 1 : 2008 (SIL2)

confirms with the essential requirements of the Machinery Directive 2006/42/EC, based on the following specifications applied

- EU Harmonized Standards
- EN61496 - 1 : 2013 (Type3 ESPE)
- IEC61496 - 3 : 2008 (Type3 ESPE)
- IEC61508 - 1 : 2010 (SIL1 - 2)
- IEC61508 - 2 : 2010 (SIL1 - 2)
- IEC61508 - 3 : 2010 (SIL1 - 2)
- IEC61508 - 4 : 2010 (SIL1 - 2)
- EN62061 : 2005 + A2 : 2015
- EN ISO13849 - 1 : 2015 (Cat.3, PL d)

The following Notified Body has issued a positive Statement of Opinion.

Notified Body reference	E6 11 01 26630 001
Identification of statement	0123
Name and address of NB	TÜV SÜD Product Service GmbH Ridlerstrasse 65 80039 Muenchen Germany

confirms with the essential requirements of the RoHS Directive 2011/65/EU, based on the following specifications applied

- EU Harmonized Standards
- EN50581 : 2012

Done at Osaka, Japan

On November 22.2018



Masayuki Maeda
General Manager
Quality Control Department



15. Revision history

Amended No.	Revision date	Details
-	September 2015	First Release
1	November 2015	UL directives and standards added, Error correction
2	January 2017	Standards updated, Connector model added Following sections added and/or modified <ul style="list-style-type: none"> ● Default configuration values added ● 7-segment upside down display function added ● Laser off mode added ● Scan skip function added ● Minimum detection width of 150mm added ● Encoder tolerance modified ● Area and measurement data inverting and rotating function added ● Compatibility with Windows 10 ● Other minor corrections
3	December 2017	<ul style="list-style-type: none"> ● Minimum detection width of 40mm added ● Optical window contamination warning function added ● Response time of reference monitoring function added ● Import and export function for area information added ● Method to generate polygonal shape for the area added ● Method to generated area using the teaching function is modified. ● Method to specify region for the teaching function is added. ● Other minor corrections
4	January 2019	<ul style="list-style-type: none"> ● Encoder pattern added (8 patterns) ● Event recording function added ● Error log time display ● Other minor corrections
5	May 2020	<ul style="list-style-type: none"> ● Table added to show the compatible functions for the respective version. ● Axillary output function added ● Area added when encoder input function is used (up to 128) ● Individual encoder check function added ● Other minor corrections
6	July 2021	Minor corrections



16. Representative contacts

- **Asia and others**

Hokuyo Automatic Co., Ltd.

Higobashi Union building, 1-9-6 Edobori, Nishi-ku, Osaka, 550-0002 Japan

Tel: +81-6-6441-2212

Fax: +81-6-6441-2203

E-mail: overseas-sales@hokuyo-aut.co.jp

URL: <http://www.hokuyo-aut.jp>

- **Europe**

Hokuyo Automatic Co., Ltd.

Amsterdam Branch

Prof. J. H. Bavincklaan 2, 1183 AT Amstelveen, The Netherlands

Tel: +31 20 240 01 10

E-mail: amsterdam.branch@hokuyo-aut.co.jp

URL: <http://www.hokuyo-aut.jp>

- **North America**

Hokuyo Automatic USA Corporation

2019 Van Buren Ave, Suite A, Indian Trail, NC 28079, U.S.A.

Tel : +1-704-882-3844 Fax : +1-704-628-0582

E-mail : sales@hokuyo-usa.com

URL : <http://www.hokuyo.com>

★ The contents described in this document are based on the information as of July 2021. The external dimensions, specifications etc. are subject to change without notice.



Higobashi Union Building, 1-9-6 Edobori, Nishi-ku, Osaka,
550-0002 Japan
TEL: +81-6-6441-2212 FAX: +81-6-6441-2203
URL: <http://www.hokuyo-aut.jp>
Email: overseas-sales@hokuyo-aut.co.jp